



Go Digital



www.bchindia.com

PRICE LIST

Effective : 6th June 2019



ENCLOSURES



BCH
ELECTRIC
LIMITED

Modern facilities at Faridabad & Rudrapur



Our Strengths

- ◆ State-of-the-art product development and R&D
- ◆ Modern manufacturing facilities
- ◆ Tool room with latest facilities
- ◆ Serving customers for five decades
- ◆ Presence in ~50 locations
- ◆ 650 channel partners
- ◆ ISO 14001:2015 and ISO 9001:2015 certified company

Core Values

- ◆ Integrity
- ◆ Nurturing People
- ◆ Commitment to Customers
- ◆ Striving for Excellence
- ◆ Long Term Thinking

Quality Policy

We as a member of BCH Electric Limited manufacturer of Low Voltage Switchgear & Controlgear products, are fully committed to provide Quality products and service in compliance with applicable Statutory and Regulatory requirements, to meet or exceed the customer need and expectations through -

- ◆ Continual improvement
- ◆ Involvement of employees
- ◆ Setting Quality objectives
- ◆ Training and development of employees

Health & Safety Policy

We as a member of BCH Electric Limited manufacturer of Low Voltage Switchgear & Controlgear products, are fully committed to conduct Business in compliance to applicable Health & Safety legislation and regulation.

We shall continually improve through -

- ◆ Provide Safe & Healthy working conditions for the prevention of work related injury and ill health.
- ◆ Develop & maintain the Health & Safety objectives & targets and conduct health & safety programs for achieving the objectives and target.
- ◆ The prevention of accidents through the identification, assessment and elimination of workplace hazards and the promotion of health & safety awareness among its employees and contractors.
- ◆ Encourage employee's participation and consultation in matters affecting the health, safety and well being of our people and seek suggestions from our employees of ways in which health, safety & well being can be furthered.

The Health & safety policy is publicly available on request.

Environmental Policy

We as a member of BCH Electric Limited manufacturer of Low Voltage Switchgear & Controlgear products, are fully committed to conduct Business in compliance to applicable Environmental legislation and regulation.

We shall continually improve through -

- ◆ Provide a framework for setting and reviewing environmental objectives and targets.
- ◆ Regularly review the impact of our activities on environment and strive to reduce the pollution/waste.
- ◆ Involve employees in our environmental program and provide necessary training to enable them to discharge their responsibilities towards environment management.
- ◆ Sustain the program of continual improvement in environment in environmental performance incorporating suitable metrics and monitoring.

The Environment policy is publicly available on request.

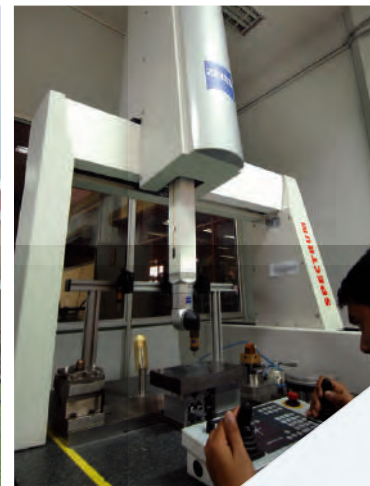

www.bchindia.com

Enclosure Systems

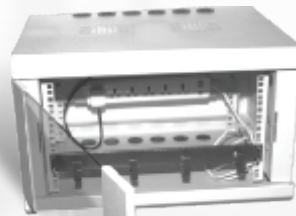
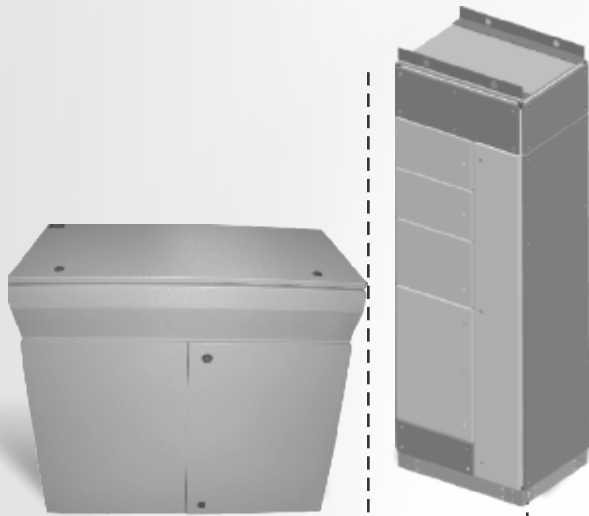

- **Bhartia Boxes IP: 55, IP: 66** 2
- **'BCH-SS' (Stainless Steel) Boxes** 3
- **Terminal Boxes IP:55 & IP:66** 3
- **Techno - Modular Enclosures** 4-5
- **Smartline - Modular Enclosures** 6
- **Semi-Modular Enclosure** 7
- **TEOS Plus Enclosure** 8
- **Compartmentalized Enclosure (Fixed & Draw-out)** 9
- **IT Racks - 19" and ETSI Racks** 10-12

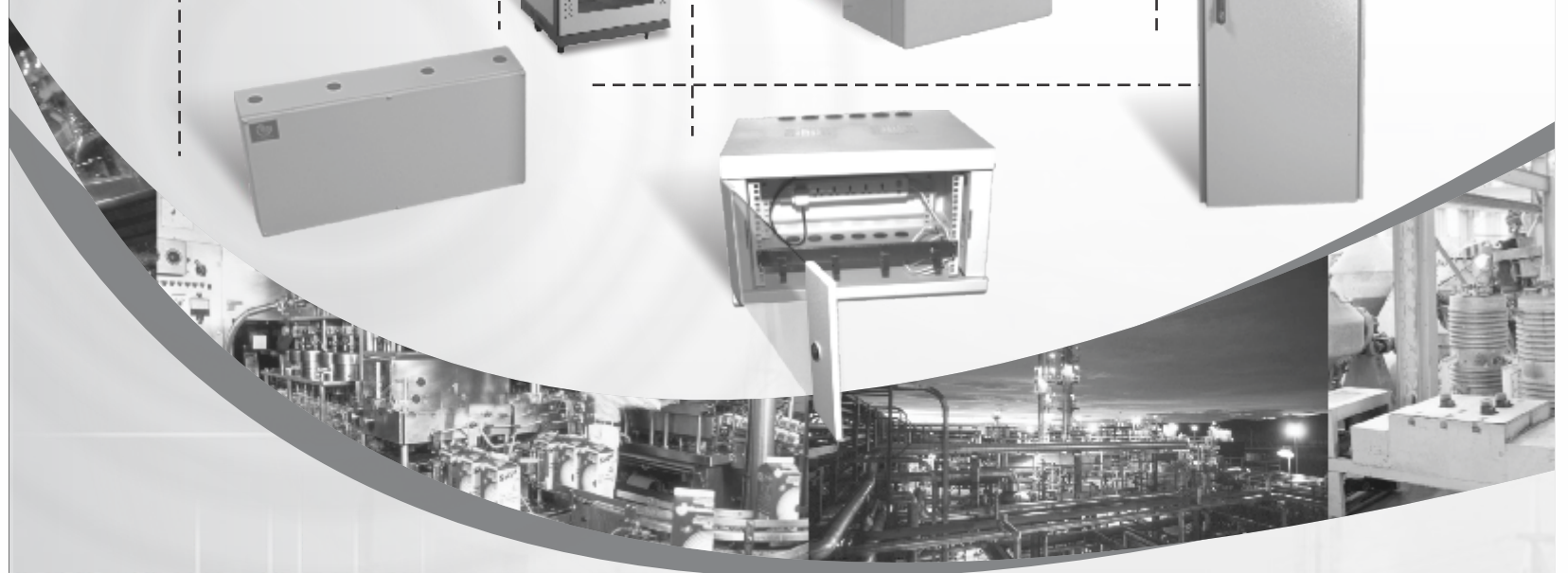

Enclosure Systems

BCH

Bhartia Boxes

HSN Code : 8538



- 51 Different Versions
- Single/Double door versions
- Min. Size : 200 X 200 X 150
- Max Size : 1200 X 1400 X 400
- IP 55/IP66

Double door version

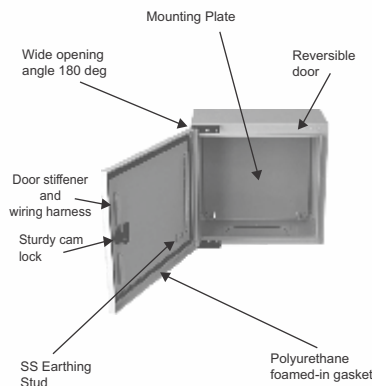

Technical Particulars (BHARTIA BOXES)

- Fabricated from 1.2mm / 1.6mm CRCA sheet steel (Sizes upto BIL-50180 made from 1.2mm CRCA, beyond this using 1.6mm CRCA)
- Foamed-in PU gasket
- Hinged door, interchangeable LHS / RHS, opening angle 180 deg for standard hinge & 120 deg for concealed hinge in bigger sizes.
- IP-55 & 66 Degree of protection
- Cable gland plate 2mm thick provided at bottom
- Cam locking arrangement
- Powder coated to RAL : 7035 structure finish
- Mounting Plate made up of 2.0mm Galvanised steel

Note : Cutout charges will be extra

: Wall mounting bracket set is an additional accessory (for Bhartia Box & Terminal box it is not a part of standard packing)

HSN Code : 8538

Type	Cat. No.	MOQ	List Price [₹]
Set of Wall Mounting bracket (small)	BIL-WM-S	1	115
Set of Wall Mounting bracket (big)	BIL-WM-B	1	135
Set of Wall Mounting bracket Kit 20mm	BIL-WM-H20	1	200

Note :

* Set of wall mounting bracket (small) is suitable for all range of terminal boxes and Bhartia boxes upto size : 400x500x200mm.

* Set of wall mounting bracket (big) is suitable for Bhartia boxes beyond size : 400x500x200mm.

Effective from 06.06.2019

Type	Size (WxHxD) mm	IP-55 Range			IP-66 Range	
		MOQ Nos.	Cat. No.	List Price [₹]	Cat. No.	List Price [₹]
SINGLE DOOR BOX	200x200x150	1	BIL-50000	1950	BIL-60000	2050
SINGLE DOOR BOX	200x300x150	1	BIL-50010	2230	BIL-60010	2280
SINGLE DOOR BOX	250x300x150	1	BIL-50020	2320	BIL-60020	2390
SINGLE DOOR BOX	300x300x150	1	BIL-50030	2500	BIL-60030	2600
SINGLE DOOR BOX	300x300x200	1	BIL-50050	2670	BIL-60050	2820
SINGLE DOOR BOX	300x400x150	1	BIL-50060	2780	BIL-60060	2930
SINGLE DOOR BOX	300x400x200	1	BIL-50080	3120	BIL-60080	3140
SINGLE DOOR BOX	400x300x150	1	BIL-50090	2720	BIL-60090	2890
SINGLE DOOR BOX	400x300x200	1	BIL-50110	3060	BIL-60110	3100
SINGLE DOOR BOX	400x400x150	1	BIL-50120	3120	BIL-60120	3180
SINGLE DOOR BOX	400x400x200	1	BIL-50140	3310	BIL-60140	3410
SINGLE DOOR BOX	400x500x150	1	BIL-50150	3520	BIL-60150	3700
SINGLE DOOR BOX	400x500x200	1	BIL-50170	3730	BIL-60170	3830
SINGLE DOOR BOX	500x500x200	1	BIL-50180	4400		
SINGLE DOOR BOX	400x600x200	1	BIL-50190	4400	BIL-60190	4460
SINGLE DOOR BOX	500x600x200	1	BIL-50210	5050	BIL-60210	5200
SINGLE DOOR BOX	500x700x200	1	BIL-50220	5740		
SINGLE DOOR BOX	500x700x300	1	BIL-50230	6600		
SINGLE DOOR BOX	600x400x200	1	BIL-50240	4480	BIL-60240	4650
SINGLE DOOR BOX	600x400x300	1	BIL-50250	5760		
SINGLE DOOR BOX	600x500x200	1	BIL-50260	5200	BIL-60260	5620
SINGLE DOOR BOX	600x600x200	1	BIL-50270	5410		
SINGLE DOOR BOX	600x600x300	1	BIL-50280	6500		
SINGLE DOOR BOX	600x700x200	1	BIL-50290	6520		
SINGLE DOOR BOX	600x800x200	1	BIL-50300	6540		
SINGLE DOOR BOX	600x800x300	1	BIL-50320	7480		
SINGLE DOOR BOX	600x1000x200	1	BIL-50330	8240		
SINGLE DOOR BOX	600x1000x300	1	BIL-50340	9350		
SINGLE DOOR BOX	800x800x300	1	BIL-50310	8720		
SINGLE DOOR BOX	800x1000x200	1	BIL-50350	9710		
SINGLE DOOR BOX	800x1000x250	1	BIL-50360	9920		
SINGLE DOOR BOX	800x1000x300	1	BIL-50390	10030		
SINGLE DOOR BOX	800x1200x300	1	BIL-50395	12500		
DOUBLE DOOR BOX	1000x800x200	1	BIL-50500	10480		
DOUBLE DOOR BOX	1000x800x300	1	BIL-50520	12020		
DOUBLE DOOR BOX	1000x1000x300	1	BIL-50540	13980		
DOUBLE DOOR BOX	1000x1200x300	1	BIL-50550	16070		
DOUBLE DOOR BOX	1000x1400x300	1	BIL-50560	19220		
DOUBLE DOOR BOX	1200x1400x300	1	BIL-50570	21370		
DOUBLE DOOR BOX	1000x1400x400	1	BIL-50580	20270		
DOUBLE DOOR BOX	1200x1400x400	1	BIL-50590	22310		

MOQ. Minimum order quantity in nos.

Canopy for Bhartia Boxes

HSN Code : 8538

Size (WxHxD) mm	Cat. No.	MOQ Nos.	List Price [₹]	Size (WxHxD) mm	Cat. No.	MOQ Nos.	List Price [₹]
200WX150D	BIL-12-CAN-2015	1	510	600WX200D	BIL-16-CAN-6020	1	980
250WX150D	BIL-12-CAN-2515	1	580	600WX300D	BIL-16-CAN-6030	1	1200
300WX150D	BIL-12-CAN-3015	1	620	800WX300D	BIL-16-CAN-8030	1	1470
300WX200D	BIL-12-CAN-3020	1	680	800WX200D	BIL-16-CAN-8020	1	1190
400WX150D	BIL-12-CAN-4015	1	700	800WX250D	BIL-16-CAN-8025	1	1290
400WX200D	BIL-12-CAN-4020	1	780	1000WX200D	BIL-16-CAN-1020	1	1400
500WX200D	BIL-12-CAN-5020	1	880	1000WX300D	BIL-16-CAN-1030	1	1720
500WX300D	BIL-12-CAN-5030	1	1080				

*List Prices are Ex-works Faridabad. For detail refer Enclosure Selling Terms & Conditions.

*GST to be charged extra



Enclosure Systems BCH



- Fabricated from 1.2/1.6 mm stainless steel sheet
- Mounting Plate made up of 2.0mm Galvanised steel
- SS grade 304
- Foamed - in PU gasket
- Box upto BIL - 90405020 is made up of 1.2 mm SS & above of 1.6 MM SS.
- 120 deg door open-able concealed hinge door with cam locking arrangement.

'BCH - SS' (Stainless Steel)

HSN Code : 8538

Type	Size (WxHxD) mm	MOQ Nos.	Cat No.	List Price [₹]
SINGLE DOOR BOX	200X300X150	3	BIL-90203015	5140
SINGLE DOOR BOX	300X300X200	3	BIL-90303020	7120
SINGLE DOOR BOX	400X400X200	3	BIL-90404020	9420
SINGLE DOOR BOX	400X500X200	3	BIL-90405020	10490
SINGLE DOOR BOX	400X600X200	3	BIL-90406020	12030
SINGLE DOOR BOX	500X600X200	3	BIL-90506020	15410
SINGLE DOOR BOX	600X600X200	3	BIL-90606020	16480
SINGLE DOOR BOX	600X800X200	3	BIL-90608020	19580
SINGLE DOOR BOX	500X700X300	3	BIL-90507030	19900
SINGLE DOOR BOX	800X800X300	3	BIL-90808030	27390

MOQ - Minimum order quantity in nos.
Note - SS grade 304

Terminal Boxes

HSN Code : 8538



- 43 Different Versions
- Min. Size : 150 X 150 X 80
- Max Size : 800 X 400 X 120
- IP 55/IP66

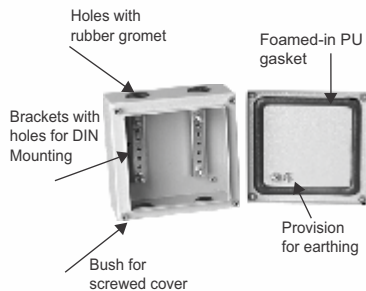

Technical Particulars (TERMINAL BOXES)

- Fabricated from 1.2mm CRCA sheet steel
- Powder coated to shade RAL 7035 Structure finish
- Foamed-in PU gasket
- Provided with screwed cover on top
- IP-55 & 66 Degree of protection
- Brackets provided inside to facilitate DIN rail mounting
- Holes with Gromet provided to facilitate cable entry in IP 55 terminal boxes

Note: Cutout charges will be extra

Box Size (W x H x D)	IP-55 Range			IP-66 Range	
	MOQ	Cat. No.	List Price [₹]	Cat. No.	List Price [₹]
150x150x80	5	BIL-70000	970	BIL-80000	1000
200x150x80	-			BIL-80100	1100
300x150x80	5	BIL-70010	1140	BIL-80010	1270
200x200x80	5	BIL-70020	1090	BIL-80020	1160
300x200x80	5	BIL-70030	1190	BIL-80030	1240
400x200x80	-			BIL-80110	1320
600x200x80	-			BIL-80130	1810
150x150x120	5	BIL-70040	1070	BIL-80040	1140
200x150x120	-			BIL-80150	1180
300x150x120	5	BIL-70050	1270	BIL-80050	1300
200x200x120	5	BIL-70060	1240	BIL-80060	1270
300x200x120	5	BIL-70070	1380	BIL-80070	1410
400x200x120	5	BIL-70080	1550	BIL-80080	1600
300x300x120	5	BIL-70090	1650	BIL-80090	1710
400x150x120	-			BIL-80170	1530
400x300x120	5	BIL-70180	1820	BIL-80180	2050
400x400x120	5	BIL-70190	2150	BIL-80190	2320
500x200x120	5	BIL-70200	1880	BIL-80200	2010
500x300x120	5	BIL-70210	2090	BIL-80210	2210
600x200x120	5	BIL-70220	2100	BIL-80220	2220
600x300x120	5	BIL-70230	2570	BIL-80230	2680
600x400x120	5	BIL-70240	2820	BIL-80240	2920
800x200x120	5	BIL-70250	2970	BIL-80250	3070
800x400x120	5	BIL-70260	3620	BIL-80260	3690

MOQ-Minimum order quantity in nos.

*List Prices are Ex-works Faridabad. For detail refer Enclosure Selling Terms & Conditions.

***GST to be charged extra**

Enclosure Systems BCH

Techno Modular Enclosures

HSN Code : 8538

Size of Enclosure (W x H x D in mm)	Cat. No.	Enclosure Version*				Plinth		Side Covers (Pair)	
		Ver 001 LP [₹]	Ver 002 LP [₹]	Ver 003 LP [₹]	Ver 004 LP [₹]	Cat. No.	List Price [₹]	Cat. No.	List Price [₹]
600 x 1800 x 400	TME 061804	19260	21450	15300	17660	TPL 061804	1870	TSC 061804	3730
800 x 1800 x 400	TME 081804	23010	25250	17490	20220	TPL 081804	2130	TSC 081804	3730
1000 x 1800 x 400	TME 101804	31670	34130	24560	26860	TPL 101804	2390	TSC 101804	3730
1200 x 1800 x 400	TME 121804	35580	39750	27610	30600	TPL 121804	2620	TSC 121804	3730
600 x 1800 x 500	TME 061805	20120	22150	16320	18350	TPL 061805	2000	TSC 061805	4330
800 x 1800 x 500	TME 081805	23430	26380	18730	20970	TPL 081805	2250	TSC 081805	4330
1000 x 1800 x 500	TME 101805	32530	34990	25630	28250	TPL 101805	2510	TSC 101805	4330
1200 x 1800 x 500	TME 121805	36270	41200	29050	32640	TPL 121805	2730	TSC 121805	4330
800 x 1800 x 600	TME 081806	24980	26220	20330	22260	TPL 081806	2350	TSC 081806	4820
600 x 2000 x 400	TME 062004	20760	23330	15940	18940	TPL 062004	1870	TSC 062004	4010
800 x 2000 x 400	TME 082004	24160	26540	18460	20960	TPL 082004	2130	TSC 082004	4010
1000 x 2000 x 400	TME 102004	34610	36540	26910	28780	TPL 102004	2390	TSC 102004	4010
1200 x 2000 x 400	TME 122004	37180	41090	29750	33710	TPL 122004	2620	TSC 122004	4010
600 x 2000 x 500	TME 062005	22040	23860	18080	20440	TPL 062005	2000	TSC 062005	4710
800 x 2000 x 500	TME 082005	24720	27290	19050	21720	TPL 082005	2250	TSC 082005	4710
1000 x 2000 x 500	TME 102005	34240	38310	27290	30280	TPL 102005	2510	TSC 102005	4710
1200 x 2000 x 500	TME 122005	37440	41200	29430	32640	TPL 122005	2730	TSC 122005	4710
600 x 2000 x 600	TME 062006	22360	24560	19150	21350	TPL 062006	2110	TSC 062006	5240
800 x 2000 x 600	TME 082006	25570	27870	20540	22840	TPL 082006	2350	TSC 082006	5240
1000 x 2000 x 600	TME 102006	34780	39910	27710	32310	TPL 102006	2600	TSC 102006	5240
1200 x 2000 x 600	TME 122006	38180	42320	30920	34880	TPL 122006	2840	TSC 122006	5240
600 x 2000 x 800	TME 062008	23010	24720	19210	21610	TPL 062008	2350	TSC 062008	6740
800 x 2000 x 800	TME 082008	26640	28620	21770	23840	TPL 082008	2600	TSC 082008	6740
1000 x 2000 x 800	TME 102008	38180	40710	29430	32640	TPL 102008	2810	TSC 102008	6740
1200 x 2000 x 800	TME 122008	40130	44510	32960	36270	TPL 122008	3090	TSC 122008	6740
600 x 2200 x 600	TME 062206	25200	27610	20010	23750	TPL 062206	2110	TSC 062206	6070
800 x 2200 x 600	TME 082206	28520	30390	22950	25310	TPL 082206	2350	TSC 082206	6070
1000 x 2200 x 600	TME 102206	39480	42530	32440	35490	TPL 102206	2600	TSC 102206	6070
1200 x 2200 x 600	TME 122206	41030	45800	31890	35630	TPL 122206	2840	TSC 122206	6070
600 x 2200 x 800	TME 062208	27480	29810	21080	24340	TPL 062208	2350	TSC 062208	7890
800 x 2200 x 800	TME 082208	33170	35100	25470	27710	TPL 082208	2600	TSC 082208	7890
1000 x 2200 x 800	TME 102208	42050	45310	34130	36700	TPL 102208	2810	TSC 102208	7890
1200 x 2200 x 800	TME 122208	45480	48040	37240	39750	TPL 122208	3090	TSC 122208	7890

*Baying kit (BIL-14280) Rs. 1260/- is also available for Enclosure Version. For extra accessories, please contact nearest branch office.

MOQ-Minimum order quantity in nos.

Note : Cutout charges will be extra

Freight charges will be extra at actuals

*List Prices are Ex-works Faridabad. For detail refer Enclosure Selling Terms & Conditions.

***GST to be charged extra**

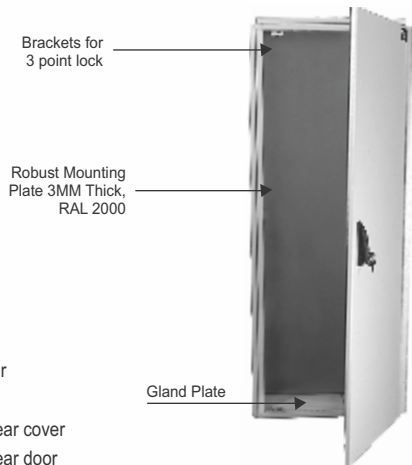

Modular Enclosures

- Enclosures
- Minimum size in mm :
600 x 1800 x 400 (W x H x D)
- Maximum size in mm :
1200 x 2200 x 800 (W x H x D)
- IP 54 / IP 55 degree of protection
- Wide range of accessories

Features

- Completely modular in all the three axis
- Powder coated surface (RAL 7035) for excellent finish and durability
- PU Gasket ensuring higher degree of ingress protection
- 3mm mounting plate as a standard
- Manufactured on CNC Turret punch press for higher precision, finish and repeated accuracy
- Ideal for :
 - Special purpose machines
 - Control panels
 - Drives
 - Starter enclosures
 - Accessories for mounting 19" equipment

Enclosure Versions

- 001 - with mounting plate and rear cover
- 002 - with mounting plate and rear door
- 003 - without mounting plate and with rear cover
- 004 - without mounting plate and with rear door

To Order And Calculate List Price

- (a) Choose Cat. No. and LP of Enclosure version from 001, 002, 003 or 004
- (b) Add Cat. No. and LP of Plinth
- (c) Add Cat. No. and LP of Side Covers pair

General Technical Particulars

- IP54/55 degree of protection
- Fabricated from 2/1.6 mm CRCA/GPSP (frame made up of 2.0mm GPSP, doors & covers made up of 1.6 mm CRCA).
- Fully bolted construction
- Mounting Plate with sliding arrangement - standard & Powder coated to RAL-2000
- Modular Plinth (optional) 100mm high fabricated from CRCA
- Cable entry provision is given from Bottom & made in 3-part construction with Galvanized steel [Unpainted]
- Foamed-in PU gasket
- Powder coated to RAL : 7035 structure finish
- Hinge design allows 120 deg. Door opening
- 3 point lock provided as standard
- Door stiffener with provision of drilling holes for wiring harness.
- Side Covers - Pair : consisting of 1no. LHS and 1no. RHS cover
- To calculate limiting dimension of the enclosure, add 44mm to the width to account for Side Covers,
- 22mm to the height for Top Cover & 44mm to the depth on account of Front and Rear door / cover.

Note : upto 800 mm width single door
1000 mm & 1200 mm width double leaf door

***List Prices are Ex-works Faridabad. For detail refer Enclosure Selling Terms & Conditions.
*GST to be charged extra**



Smartline Modular Enclosure BCH

SmartLine TME

HSN Code : 8538

Size of Enclosure (W x H x D in mm)	Cat. No.	Enclosure Version*				Plinth		Side Covers (Pair)	
		Ver 001 LP [₹]	Ver 002 LP [₹]	Ver 003 LP [₹]	Ver 004 LP [₹]	Cat. No.	List Price [₹]	Cat. No.	List Price [₹]
600 x 1800 x 500	SLE 061805	18730	21190	15190	17490	TPL 061805	2000	SLSC 061805	3910
800 x 1800 x 600	SLE 081806	23330	25040	19150	21290	TPL 081806	2350	SLSC 081806	4330
600 x 2000 x 600	SLE 062006	20870	23330	17870	20010	TPL 062006	2110	SLSC 062006	4730
800 x 2000 x 600	SLE 082006	23910	26480	19210	21710	TPL 082006	2350	SLSC 082006	4730
1200 x 2000 x 600	SLE 122006	36330	40210	29430	33140	TPL122006	2840	SLSC 122006	4730
600 x 2000 x 800	SLE 062008	21350	23490	17980	20280	TPL 062008	2350	SLSC 062008	6080
800 x 2000 x 800	SLE 082008	25310	27180	20280	22630	TPL 082008	2600	SLSC 082008	6080
1200 x 2000 x 800	SLE 122008	37340	42370	31350	34490	TPL 122008	3090	SLSC 122008	6080

Note : Cutout / customization charges will be extra.

*Baying kit (**BIL-14280**) Rs. 1260/- is also available for Enclosure Version. For extra accessories, please contact nearest branch office.

Enclosure Versions

- 001 - With mounting plate and rear cover.
- 002 - With mounting plate and rear door
- 003 - Without mounting plate and with rear cover
- 004 - Without mounting plate and with rear door

To Order and Calculate List Price

- (a) Choose Cat. No. and LP of Enclosure version from 001, 002, 003 or 004
- (b) Add Cat. No. and LP of Plinth
- (c) Add Cat. No. and LP of Side Covers pair

General Technical Particulars

- IP-54 degree of protection
- Fabricated from CRCA/GPSP (frame made up of GPSP, doors & covers made up of CRCA sheet).
- Modular construction
- Mounting plate and cable entry plate made up of Galvanized steel [Unpainted]
- Plinth (optional) 100mm high fabricated from CRCA sheet.
- Cable entry provision is given from Bottom as standard
- Foamed-in PU gasket
- Powder coated to RAL : 7035 structure finish
- Hinge design allows 120 deg. Door opening
- 3 point lock provided as standard
- Door stiffener with provision of drilling holes for wiring harness.
- Side Covers - Pair: consisting of 1no. LHS and 1no. RHS cover
- To calculate limiting dimension of the enclosure, add 44mm to the width to account for Side Covers, 22mm to the height for Top Cover & 44mm to the depth on account of Front and Rear door / cover.

Note : Upto 800 mm width single door. 1000 mm & 1200 mm width double leaf door

*List Prices are Ex-works Faridabad. For detail refer Enclosure Selling Terms & Conditions.

***GST to be charged extra**



Semi-Modular Floor Standing Enclosure BCH

HSN Code : 8538

Size of Enclosure (W x H x D in mm)	Cat. No.	List Price [₹]	Plinth		Side Covers (Pair)	
			Cat. No.	List Price [₹]	Cat. No.	List Price [₹]
600X1800X400	FCS 061804	On Request	FCS-PL 061804	On Request	FCS-SC 061804	On Request
600X1800X500	FCS 061805		FCS-PL 061805			
800X1800X600	FCS 081806		FCS-PL 081806			
600X2000X600	FCS 062006		FCS-PL 062006			
800X2000X500	FCS 082005		FCS-PL 082005			
800X2000X600	FCS 082006		FCS-PL 082006			
800X2000X800	FCS 082008		FCS-PL 082008			
1000X2000X600	FCS 102006		FCS-PL 102006			
1000X2000X800	FCS 102008		FCS-PL 102008			
1200X2000X500	FCS 122005		FCS-PL 122005			
1200X2000X600	FCS122006		FCS-PL122006			
1200X2000X800	FCS 122008		FCS-PL 122008			

Note : Sizes are available in all FOUR version like TME.

Enclosure Versions

Ver-001 - With mounting plate and rear cover.

Ver-002 - With mounting plate and rear door

Ver-003 - Without mounting plate and with rear cover

Ver-004 - Without mounting plate and with rear door

To Order and Calculate List Price

- Choose Cat. No. and LP of Enclosure version from 001, 002, 003 or 004
- Add Cat. No. and LP of Plinth
- Add Cat. No. and LP of Side Covers pair

Note:

- Cutout / customization charges will be extra.
- Baying Kit (BIL-FCS-14280) LP Rs. 1000/- is also available for Enclosure Versions.
- For extra accessories, Please contact nearest branch office.



Technical Particulars (Semi-Modular Enclosure)

- Unique symmetric front and rear welded frame with modular depth member which resultant fastest assembly and uniformity.
- IP-55 Degree of Protection
- Front and Rear Frame welded & depth members are modular
- Fabricated from 2.0mm/1.6mm CRCA
- Mounting plate made of 2mm thick Galvanized sheet
- Cable entry from bottom of panel as standard
- Powder coated to RAL-7035 Structure finish
- Limiting dimension of the enclosure are same as per sizes given
- Adjustable mounting plate depth wise
- Foamed-in PU gasket
- 3 point lock provided as standard
- Door stiffener with provision of drilling holes for wiring harness.
- Side Covers - Flush Type Side cover Pair consisting of 1no LHS and 1no RHS cover

*List Prices are Ex-works Faridabad. For detail refer Enclosure Selling Terms & Conditions.

***GST to be charged extra**



TEOS Plus Enclosure BCH-TEKPAN

TEOS Plus Enclosure

HSN Code : 8538

Size of Enclosure (W x H x D in mm)	Cat. No.	List Price [₹]
600 x 1800 x 500	TEOS061805	On Request
800 x 1800 x 600	TEOS081806	
600 x 2000 x 600	TEOS062006	
800 x 2000 x 600	TEOS082006	
800 x 2000 x 800	TEOS082008	
1200 x 2000 x 600	TEOS122006	
1000 x 2000 x 800	TEOS102008	
1200 x 2000 x 800	TEOS122008	

Front Door, Rear Door, Rear Cover & Mounting plate shall be supplied as per requirement.

Plinth Corner

HSN Code : 8538

Description	Cat. No.	List Price [₹]
PLINTH CORNER PART H100mm	708.100	On Request

Supply included:- 4 pcs 100mm height corner & mounting accessories.

Plinth Front Cover

HSN Code : 8538

Description	Cat. No.	List Price [₹]	
PLINTH FRONT PROFILE :600	709.160	On Request	
PLINTH FRONT PROFILE :800	709.180		
PLINTH FRONT PROFILE :1000	709.100		
PLINTH FRONT PROFILE :1200	709.120		

Supply included:- 2 pcs 100mm height front cover & mounting accessories.

Plinth Side Cover

HSN Code : 8538

Description	Cat. No.	List Price [₹]	
PLINTH SIDE PROFILE :500	710.150	On Request	
PLINTH SIDE PROFILE :600	710.160		
PLINTH SIDE PROFILE :800	710.180		

Supply included:- 2 pcs 100mm height side cover & mounting accessories.

Side Cover

HSN Code : 8538

Description	Cat. No.	List Price [₹]	
Pair of side cover 500*1800	706.185	On Request	
Pair of side cover 600*1800	706.186		
Pair of side cover 600*2000	706.206		
Pair of side cover 800*1800	706.188		
Pair of side cover 800*2000	706.208		

Supply included:- 2 pcs side cover & mounting accessories

Technical Particulars (TEOS Plus Enclosure)

- Multifold (12-Fold) structure with 100% Modularity.
- IP-65 Degree of Protection.
- SEISMIC Tested for Zone-4 and UL Certified.
- Easy Assembly & Logistic advantages.
- 4-Point lock with Swing Handle.
- Powder coated to RAL: 7035 Structure Finish.
- Limiting dimension of the enclosure are same as per given dimension.

*List Prices are Ex-works Faridabad. For detail refer Enclosure Selling Terms & Conditions.

*GST to be charged extra



Note :

- Upto 800 mm width single door . 1000 mm & 1200 mm width double leaf door
- Cutout / customization charges will be extra
- For extra accessories, please contact nearest branch office.

Highlights of **BCH Compartmentalized MCC / PCC / PMCC Solution (Fixed & Drawed Type)**

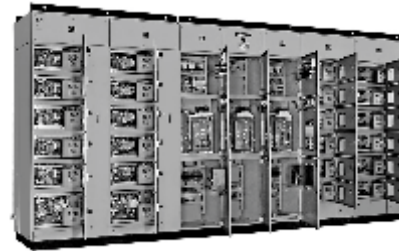

- 100% Modular Structure; can be dispatched in flat pack.
- Flexible compartmentalized - up to From 4.
- IP 54 degree of protection with polyurethane foam gasket.
- Compartment size available from 200mm height & multiplies of 100mm.
- Additional accessories like Cable support, Busbar support, Limit Switch and Lamp brackets are available.
- Adjustable mounting plates (Depth wise at the pitch of 25mm).
- Panel can be expended in all 3 dimensions and bayed together by using Baying Kit.
- All Structure members (Corner & Cross bar) having M6 extrude hole at 25mm intervals, No need of any Captive hardware.
- Standard Module dimension for Drawout Enclosures.
 - ▷ Single Front :- 900(W) x 2400(H) x 600(D)
 - ▷ Double Front :- 900(W) x 2400(H) x 1200(D)
- Draw-out feeder available from 200mm height (2SU) to 800mm height (8SU).
- Colours :- RAL-7035 (Structure finish) for structure, doors, covers & internal parts RAL-2000 (smooth finish) for Mounting plates, Ral-9000 (Smooth Finish) for Plinth.
- Sheet thickness 2.0mm GPSP for structure, 2.0mm CRCA for Mounting Plate & Mounting rail, 1.6mm CRCA for Doors & Covers, 1.2mm CRCA for Separation plates.

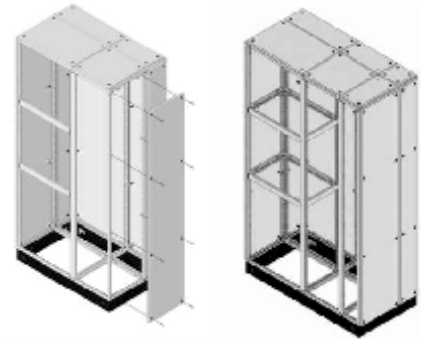

BCH Control Desk

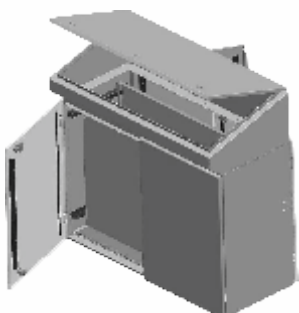

Enclosure Systems **technoRACKS** BCH

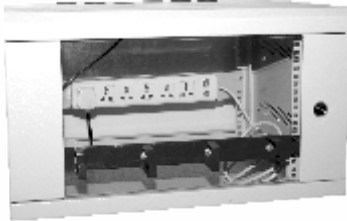

Key Attributes:

- Aesthetic & robust construction
- Mounting Fan /s in top doesn't take usable "U" space.
- Special type of Wallmounting hardware.
- Provision for earthing available in the cabinets.
- Highly corrosion resistant in nature.
- Power coated to shade RAL : 7035 structure finish.

19" Wall Mount Racks

HSN Code : 8538

Dimensions (H x W x D) mm	MOQ Nos.	Cat. No.	List Price [₹]
6UX550X400	1	BIL-W-6-5504	3840
9UX550X400	1	BIL-W-9-5504	4630
6UX550X500	1	BIL-W-6-5505	4240
9UX550X500	1	BIL-W-9-5505	4940
12UX550X500	1	BIL-W-12-5505	5490
15UX550X500	1	BIL-W-15-5505	6460

MOQ-Minimum order quantity in nos.

Standard Configuration: Wallmount cabinet, 2-Pairs of 19" rail.

Notes : Accessories viz. Shelves, Fans, power strips, cable managers captive H/W & wall mounting hardware etc. will be extra as per the accessories list furnished in the price list.
Wall mount racks price do not include freight & will be extra at actuals

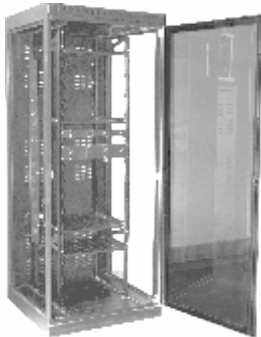

Key Attributes:

- Floor mounting robust design.
- Lockable & removable side panels.
- 2-pairs of adjustable 19" rails.
- Front door with toughened glass & perforation.
- High load bearing capacity.
- Rear vented door.
- Provision for fan mounting in top which doesn't take usable "U" Space.
- Superior cable management facility in extra wide racks.
- 4-integrated vertical cable managers are default design of 800mm wide racks.
- Rear space saving split door with 3-point secure locking in extra wide (800mm) racks.
- Power coated to shade RAL : 7035 structure finish.

19" Networking Racks

HSN Code : 8538

Dimensions (H x W x D) mm	MOQ Nos.	Cat. No.	List Price [₹]
24U X 600 X 600	1	BIL-N-062406	21490
24U X 600 X 800	1	BIL-N-062408	23760
24U X 800 X 600	1	BIL-N-082406	26930
24U X 800 X 800	1	BIL-N-082408	29430
30U X 600 X 600	1	BIL-N-063006	23760
30U X 600 X 800	1	BIL-N-063008	26030
30U X 800 X 600	1	BIL-N-083006	29430
30U X 800 X 800	1	BIL-N-083008	32260
36U X 600 X 600	1	BIL-N-063606	26030
36U X 600 X 800	1	BIL-N-063608	28860
36U X 800 X 600	1	BIL-N-083606	32270
36U X 800 X 800	1	BIL-N-083608	35040
42U X 600 X 600	1	BIL-N-064206	30000
42U X 600 X 800	1	BIL-N-064208	32150
42U X 800 X 600	1	BIL-N-084206	35310
42U X 800 X 800	1	BIL-N-084208	39040
45U X 600 X 600	1	BIL-N-064506	34520
45U X 600 X 800	1	BIL-N-064508	36230
45U X 800 X 600	1	BIL-N-084506	37910
45U X 800 X 800	1	BIL-N-084508	41310

MOQ-Minimum order quantity in nos.

Notes : 1) Networking racks price do not include freight & this will be extra at actuals.

For more details visit : www.bchindia.com/technorack

***List Prices are Ex-works Faridabad. For detail refer Enclosure Selling Terms & Conditions.**

***GST to be charged extra**

19" Server Racks

HSN Code : 8538

Key Attributes:

- Floor mounting robust design.
- Lockable & removable side panels.
- 2-pairs of adjustable 19" rails.
- Front door with toughened glass & perforation.
- High load bearing capacity.
- Rear vented door.
- Provision for fan mounting in top which doesn't take usable "U" Space.
- Superior cable management facility in extra wide racks.
- 4-integrated vertical cable managers are default design of 800mm wide racks.
- Rear space saving split door with 3-point secure locking
- locking in extra wide (800mm) racks.
- Power coated to shade RAL : 7035 structure finish.

Dimensions (H x W x D) mm	MOQ Nos.	Cat. No.	List Price [₹]
24U X 600 X 900	1	BIL-S-062409	24280
24U X 600 X 1000	1	BIL-S-062410	25800
30U X 600 X 900	1	BIL-S-063009	27450
30U X 600 X 1000	1	BIL-S-063010	28520
36U X 600 X 900	1	BIL-S-063609	30100
36U X 600 X 1000	1	BIL-S-063610	31700
42U X 600 X 900	1	BIL-S-064209	33840
42U X 600 X 1000	1	BIL-S-064210	35990
42U X 800 X 1000	1	BIL-S-084210	41420
45U X 600 X 900	1	BIL-S-064509	39110
45U X 600 X 1000	1	BIL-S-064510	41380

MOQ - Minimum order quantity in nos.

Notes : Server racks price do not include freight & this will be extra at actuals.

STANDARD CONFIGURATION: Basic frame, Top & bottom, Front Glass door with perforation, Rear vented door, Lockable & detachable side panels, 2-Pairs of 19" rails with depth members.



Key Attributes:

- Includes 1-Pair of 21" rails.
- Integrated side panels.
- Grouting arrangements along with grouting bolts as std. BOM
- Provision for power & detachable Cable entry/exit in top & bottom.
- Power coated to shade RAL : 7035 structure finish.

ETSI Racks

HSN Code : 8538

Dimensions (H x W x D) mm	MOQ Nos.	Cat. No.	List Price [₹]
2200 X 600 x 300	1	ITE-062203	8720
2200 X 600 x 600	1	ITE-062206	14040

MOQ - Minimum order quantity in nos.

Notes : Above ETSI configuration do not include front & rear door and covers. All other accessories will be extra & will be furnished on request. The prices mentioned above do not include freight.



Key Attributes:

- 1-Pair of vertical cable manager is default design.
- Surface pretreated and advance powder coated
- Grouting bolts as std. BOM.
- Power coated to shade RAL : 7035 structure finish.

19" Open Racks

HSN Code : 8538

Dimensions (H x W) mm	MOQ Nos.	Cat. No.	List Price [₹]
36U X 600	1	ITE-OF-0636	5670
45U X 600	1	ITE-OF-0645	6680

MOQ - Minimum order quantity in nos.

Notes : 1) Above Open Rack configuration does not include Shelves, Doors and Covers. All other accessories prices will be extra and will be furnished on request.

2) The Prices above do not include Freight and this will be extra at actuals.

For more details, visit : www.bchindia.com/technorack

*List Prices are Ex-works Faridabad. For detail refer Enclosure Selling Terms & Conditions.

***GST to be charged extra**

Accessories for 19" Racks

Fixed Shelf/Stationary Shelf

- Compatible to keep monitor, servers, non 19" Networking & allied equipments.

Key-Board Tray

- Sliding & rotatory type.

Canteliver Shelf

- It can accommodate light weighted networking & allied equipments like modem, routers etc.

Equipment Support Angle

- "L" type angles. Useful to keep non 19" heavy duty equipment in rack mounting position.

Sliding Shelf

- Useful to keep servers, networking & allied equipment which are required to slide out for operational & other purpose.

Fans/Fan Tray

- 220V 90 CFM Capacity. Can be mounted at the top either directly or through Fan housing unit (Fan Tray)

6-Point 5A Hor. Power Strip

- All universal type socket along with on/off switch with fuse & indicator. Internal strips are made up of Berellium copper that has high rate of heat & mechanical tolerance.
- Other 5A or 5/15A Power strips have Indian style (Anchor) Sockets with on/off switch/MCB.

Castors

- 1-Set includes 4Nos. of castors, 2Nos. with foot operated brake & remaining 2 are free.

Levelling Feet

- 1-Set includes 4Nos. of Levelling Feet.

Stability Plate

- It Prevents the racks from toppling while taking out heavy duty servers.

Shelves

HSN Code : 8538

Description	Cat No.	List Price [₹]
Fixed Shelf (600mmD)	BIL-A-FS-L-06	980
Fixed Shelf (800mmD)	BIL-A-FS-L-08	1510
Fixed Shelf (900mmD)	BIL-A-FS-L-09	1680
Fixed Shelf (1000mmD)	BIL-A-FS-L-10	1810
Modem Tray	BIL-A-MD	930
Key board tray (Sliding & Rotatory)	BIL-A-KB-06	2890
Canteliver Shelf (1U)	BIL-A-CS-1	580
Canteliver Shelf (2U)	BIL-A-CS-2	870
Equipment Support Angle (600mmD)	BIL-A-ESA-06	360
Equipment Support Angle (800mmD)	BIL-A-ESA-08	410
Equipment Support Angle (900mmD)	BIL-A-ESA-09	510
Equipment Support Angle (1000mmD)	BIL-A-ESA-10	590
Sliding Shelf (900mmD)	BIL-A-SS-09	2890
Sliding Shelf (1000mmD)	BIL-A-SS-10	3000

Thermal Management

HSN Code : 8538

Description	Cat No.	List Price [₹]
1-Fan (Direct mounted)	BIL-A-SF	980
Fan-tray with 2-Fans (FHU)	BIL-A-FHU-2FANS	2090
Fan-tray with 4-Fans (FHU)	BIL-A-FHU-4FANS	3640

Cable Management

HSN Code : 8538

Description	Cat No.	List Price [₹]
Horizontal Cable Manager (1U)	BIL-A-HCM-1U	230
Horizontal Cable Manager (2U)	BIL-A-HCM-2U	290
Vertical Cable Manager (24U)	BIL-A-VCM-24U	360
Vertical Cable Manager (30U)	BIL-A-VCM-30U	460
Vertical Cable Manager (36U)	BIL-A-VCM-36U	530
Vertical Cable Manager (42U)	BIL-A-VCM-42U	580
Vertical Cable Manager (45U)	BIL-A-VCM-45U	640

Power Management

HSN Code : 8538

Description	Cat No.	List Price [₹]
6-Point 5Amp Horizontal Power Strip (19")	BIL-A-HPS-5AMP	950
5-Point 5/15Amp Horizontal Power Strip (19")	BIL-A-HPS-15AMP	1270
12-Point 5Amp Vertical Power Strip	BIL-A-12VPS-5AMP	1860
10-Point 5/15Amp Vertical Power Strip	BIL-A-10VPS-15AMP	2140
Earth continuity Kit (Earthing Kit)	BIL-A-ECT	720

Stability Management

HSN Code : 8538

Description	Cat No.	List Price [₹]
Castors (1-Set) Heavy Duty	BIL-A-CAS-HD	3490
Castors (1-Set) Light Duty	BIL-A-CAS	2780
Levelling Feet (1-Set)	BIL-A-LF	470
Stability Plate	BIL-A-SP	1750

Miscellaneous

HSN Code : 8538

Description	Cat No.	List Price [₹]
BAYING KIT	BIL-A-BK	340
BLANKING PANEL (1U)	BIL-A-BP-1U	160
BLANKING PANEL (2U)	BIL-A-BP-2U	210
BLANKING PANEL (3U)	BIL-A-BP-3U	270
BLANKING PANEL (4U)	BIL-A-BP-4U	330
BLANKING PANEL (5U)	BIL-A-BP-5U	370
Captive H/w (set of 10)	BIL-A-Captive-M6	160
Wallmounting H/w (set of 4)	BIL-A-wallmounting W	170

Notes : Packing & forwarding will be extra if accessories are ordered separately.

*List Prices are Ex-works Faridabad. For detail refer Enclosure Selling Terms & Conditions.

***GST to be charged extra**



Price List

General Terms & Conditions

Prices are subject to change without any prior notice and will be applicable as prevailing at the time of dispatch.

- The prices are ex-works basis..
- The prices given in this list are effective as on date and are subject to change without notice.
- The List Prices (LP) mentioned are exclusive of GST.
- The duties, taxes and other statutory levies are based on rates prevailing at the time of billing. Any subsequent revision of those rates having retrospective effective shall be to customer's account.
- In case where any GST exemption has been claimed, the purchaser is responsible for providing the necessary GST exemption form within the specified period, failing which the purchaser would be liable for the payment of full GST plus applicable interest and penalties
- All Prices are in Indian Rupees (₹).
- Alteration made after receipt of confirmation of order are subject to price & delivery revisions and any other expenses or levies
- The dispute, if any, will be resolved mutually by discussion. However, if no settlement is forthcoming then, the Courts at New Delhi shall only have territorial jurisdiction to hear and decide the dispute.

Warranty

All products, unless specifically mentioned otherwise, shall have warranty, against manufacturing defects for a period of 18* months from the date of invoicing & 24 months from date of manufacturing whichever is later subject to the provision of proper usage and does not cover defects arising out of fire, accident, inefficient maintenance, faulty operation and willful or accidental damage. The manufacturer shall not be liable for any consequential loss, injury or damages attributable to defect or failure of its products.

* Proof of purchase to be retained to avail warranty.

a strong commitment
to serve better
always ...



**Switchgear | Controlgear | Enclosures | Motor Starters & Submersible Pump Starters |
Brakes and Crane Controls | MCC | PCC | Customised Solutions | Automation |
Wires & Cables | Motors | Reactive Power Management**



**BCH
ELECTRIC
LIMITED**

- Power Control Products
- Starters & Submersible Pump Starters
- Industrial Enclosures
- Industrial Products
- Wires & Cables
- Motor Control Products
- Customised Solution
- Automation

a strong commitment to serve better always ...



BCH ELECTRIC LIMITED

Visit us at : www.bchindia.com

Corporate Office : 1105, New Delhi House, 27, Barakhamba Road, New Delhi-110 001 Tel. : 91-11- 43673100/23316029/3610/6539/ Fax : 91-11-23715247

CIN : U31103WB1965PLC026427, Customercare No. 1800-103-9262, E-mail : marketing@bchindia.com

Registered Office : Block 1E, 216, Acharya Jagadish Chandra Bose Road, Kolkata - 700 017

Works 1 : 20/4, Mathura Road, Faridabad-121 006 (Haryana) Tel. : 0129-4063000/4293000 Fax : 0129-2304016

Works 2 : 64-68, Sector-7, IIE, Pant Nagar, Rudrapur, Udham Singh Nagar - 263 153 (Uttarakhand) Tel. : 05944-250214/16 Fax : 05944-250215

Sales Offices :

Ahmedabad

103, Aaron,
Nr. SBI Laghuudyug branch,
Behind Sakar-1
Gandhigram Railway station,
Ellis bridge, Ahmedabad - 380006
Tel. : 079-26589719
E-mail: ahmedabad@bchindia.com

Bangalore

2nd Floor, 130/5,
K.H. Road (Double road),
Bangalore - 560 027
Tel. : 080-22273478 / 22236759
E-mail : bangalore@bchindia.com

Bhubaneswar

Mallick Commercial
Complex Plot No.: A/69, unit - 3
Bhubaneswar - 751 001
Tel. : 0674-2380988
E-mail: bhubaneswar@bchindia.com

Chandigarh (Panchkula)

SCO -129, Iind Floor,
MDC, Sector-5 Panchkula,
Haryana-134 109
Tel. : 0172-5078957 / 5049905
E-mail: chandigarh@bchindia.com

Chennai

Flat No. 3A, 3rd Floor,
Sree Apartments,
No.508, TTK Road,
Alwarpet, Chennai 600 018
Tel.: 044-24337046, 24337047
E-mail : chennai@bchindia.com

Coimbatore

87, Dr. Nanjappa Road,
Coimbatore - 641 018
Tel. : 0422-2305311 / 2302599
E-mail : coimbatore@bchindia.com

Dehradun

8, Co-operative Industrial Estate,
Patel Nagar, Dehradun-248001
E-mail : dehradun@bchindia.com

Faridabad

20/4, Mathura Road,
Faridabad - 121 006 (Haryana)
Tel. : 0129-4293009
E-mail : faridabad@bchindia.com

Hyderabad

1-8-303/48/13/102, Arya One,
2nd Floor, P. G. Road,
Secunderabad - 500 003
Tel. : 040-66206263/27890306
Fax : 040-66207273
E-mail : hyderabad@bchindia.com

Indore

330-331, Indraprastha Tower,
3rd Floor, 6, M.G. Road,
Indore - 452 001
Tel. : 0731-2510011 / 2510012
E-mail : indore@bchindia.com

Jaipur

25, Hathroi, Gopalbari,
Jaipur - 302 001
Tel. : 0141-2363521
E-mail : jaipur@bchindia.com

Jamshedpur

3rd Floor, Aastha Trade Centre,
'Q' Road, Bistupur,
Jamshedpur - 831 001
Tel. : 0657-2321097/2321481
E-mail : jamshedpur@bchindia.com

Kolkata

Block 1E, 216,
Acharya Jagadish Chandra Bose Road,
Kolkata - 700 017
Tel. : 033-22871728 / 46021884
E-mail : kolkata@bchindia.com

Lucknow

Madan Plaza, 3rd Floor,
14, Station Road,
Lucknow - 226 001
Tel. : 0522-4025597/4025997
Fax : 0522-4025697
E-mail : lucknow@bchindia.com

Ludhiana

S.C.O.- 18, 2nd Floor,
Feeroze Gandhi Market,
Ludhiana - 140 001
Tel. : 0161-5021807/5022808
E-mail : ludhiana@bchindia.com

Mumbai

A-151, Mittal Tower,
Nariman Point,
Mumbai - 400 021
Tel. : 022-22822947/22850162
Fax : 022-22822858
E-mail : mumbai@bchindia.com

New Delhi

801, Akash Deep Building,
26A, Barakhamba Road,
New Delhi - 110 001
Tel. : 011-23313878/23739230
E-mail : delhi@bchindia.com

Pune

8, Sarosh Bhavan,
16-B/1, Dr. Ambedkar Road,
Pune - 411 001
Tel. : 020-26052590 / 26135224
E-mail : pune@bchindia.com

Raipur

2nd Floor, Building No. B-234,
Indira Gandhi Vyavasayik Parisar,
Pandri, Raipur - 492 004
Tel. : 0771-4020213 / 4045053
E-mail : raipur@bchindia.com

Trichy

2B, Kannagi Street,
Ayyappa Nagar, K.K.Nagar
Trichy - 620 021, Tamilnadu
Tel. : 0431-4040497
E-mail: trichy@bchindia.com

Vadodara

301, Third Floor, "Florence Classic",
10, Ashapuri Co-Op. Hsg. Soc. Ltd., Opp. VUDA Housing,
Near Cow Circle, Akota, Vadodara - 390 020
Tel. : 0265-2345068/2345069
Telefax : 0265-2345068,
E-mail : vadodara@bchindia.com

Other Branch Locations

Bhubaneswar : bhubaneswar@bchindia.com, **Cochin :** cochin@bchindia.com, **Gurgaon :** gurgaon@bchindia.com, **Guwahati :** guwahati@bchindia.com, **Hospet :** hospet@bchindia.com,
Hubli : hubli@bchindia.com, **Madurai :** madurai@bchindia.com, **Nagpur :** nagpur@bchindia.com, **Vishakapatnam :** vizag@bchindia.com, **Surat :** surat@bchindia.com

Resident Engineer Locations

Baddi	Gurgaon	Madurai	Rajahmundry
Bardhaman	Haridwar	Muzaffarnagar	Salem
Bhilai	Hubli	Nagpur	Surat
Bhubaneswar	Hospet	Nashik	Udaipur
Cochin	Jodhpur	Patna	Vapi
Dehradun	Kakinada	Puducherry	Vishakhapatnam
Durgapur	Kota	Rajkot	Warangal

Since product improvement is a continuous process, the data furnished in this brochure may undergo revision without prior notice.