



Go Digital



www.bchindia.com



PRICE LIST

Effective : 6th June 2019



BCH
ELECTRIC
LIMITED



Modern facilities at Faridabad & Rudrapur

Our Strengths

- ◆ State-of-the-art product development and R&D
- ◆ Modern manufacturing facilities
- ◆ Tool room with latest facilities
- ◆ Serving customers for five decades
- ◆ Presence in ~50 locations
- ◆ 650 channel partners
- ◆ ISO 14001:2015 and ISO 9001:2015 certified company

Core Values

- ◆ Integrity
- ◆ Nurturing People
- ◆ Commitment to Customers
- ◆ Striving for Excellence
- ◆ Long Term Thinking

Quality Policy

We as a member of BCH Electric Limited manufacturer of Low Voltage Switchgear & Controlgear products, are fully committed to provide Quality products and service in compliance with applicable Statutory and Regulatory requirements, to meet or exceed the customer need and expectations through -

- ◆ Continual improvement
- ◆ Involvement of employees
- ◆ Setting Quality objectives
- ◆ Training and development of employees

Health & Safety Policy

We as a member of BCH Electric Limited manufacturer of Low Voltage Switchgear & Controlgear products, are fully committed to conduct Business in compliance to applicable Health & Safety legislation and regulation.

We shall continually improve through -

- ◆ Provide Safe & Healthy working conditions for the prevention of work related injury and ill health.
- ◆ Develop & maintain the Health & Safety objectives & targets and conduct health & safety programs for achieving the objectives and target.
- ◆ The prevention of accidents through the identification, assessment and elimination of workplace hazards and the promotion of health & safety awareness among its employees and contractors.
- ◆ Encourage employee's participation and consultation in matters affecting the health, safety and well being of our people and seek suggestions from our employees of ways in which health, safety & well being can be furthered.

The Health & safety policy is publicly available on request.

Environmental Policy

We as a member of BCH Electric Limited manufacturer of Low Voltage Switchgear & Controlgear products, are fully committed to conduct Business in compliance to applicable Environmental legislation and regulation.

We shall continually improve through -

- ◆ Provide a framework for setting and reviewing environmental objectives and targets.
- ◆ Regularly review the impact of our activities on environment and strive to reduce the pollution/waste.
- ◆ Involve employees in our environmental program and provide necessary training to enable them to discharge their responsibilities towards environment management.
- ◆ Sustain the program of continual improvement in environment in environmental performance incorporating suitable metrics and monitoring.

The Environment policy is publicly available on request.

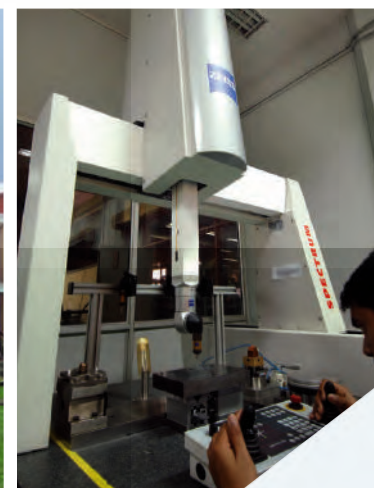

www.bchindia.com

Our Products



Switchgear & Controlgear



Motor Starters & Submersible Pump Starters



MCB & MCB Distribution Boxes



Enclosure Systems

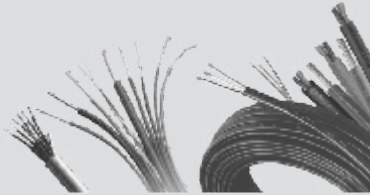

Wires & Cables

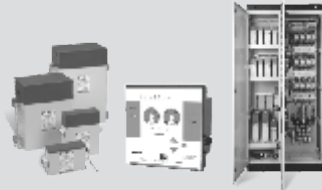

Power Factor Control Product

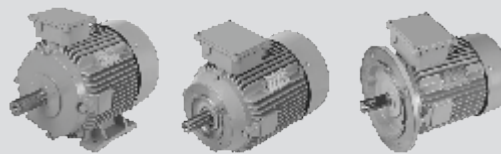

Motors



Automation Product



Motor Control Centres (MCCs), Power Control Centres (PCCs) & Custom Built Products

INDEX

Low Voltage Switch Gear & Control Gear Products

• Air Circuit Breakers	2
• MCCBs - Resilient	3
• MCB	5
• Isolators, MCB Distribution Boxes, RCCB New	6
• MCCBs - Tembreak 2	9
• Accessories - Tembreak 2 MCCB	12
• FSU, SDFU	13
• AC Contactors	14
• Overload Relays New	25
• Vacuum Contactors	27
• Electronic Overcurrent Relays (BOCR)	28
• Motor Protection Circuit Breakers (MPCB)	29
• Solid State Relays	32
• DC Contactors	35
• Limit Switches	38
• Foot Switches	41
• Push Buttons, Indicating Lights, LEDs	41
• AC Solenoids & Brakes	45
• DC Brakes	46
• Spares - DC Brakes	51
• Plugs & Sockets	52
• Plug & Socket Boxes	54
• Pneumatic Timers	55

Motor Starters & Submersible Pump Starters

• Motor Starters	56
- Shakti - DOL (Shakti WP, Shakti) & SASD	57
- Shakti - FASD, Auto-DOL & DOL SPS	58
- Citation - DOL (with NHD & Citation D Contactor) & SASD	59
- Citation - FASD, Highter HP FASD Starters & Reversing DOL	60
- FASD with EOOCR, Industrial DOL & Wireless Modem	61
- Mini Manual 1Ph & 3Ph, DOL-1Ph & Manual Star-Delta	62
• Submersible Pump Starters	63
- Citation - SPS DOL & SD (3 Position)	64
- SPS - 1 Ph DOL (with CPG Contactor & Mini Manual)	65
• Others	
- Oil Immersed DOL & Star Delta Starters (SASD & FASD)	66
- Spares for Motor Starters & Panels	67
- Auto Switch, Dual Meter (Combination of Ammeter & Voltmeter)	68

Enclosure Systems

• Bhartia Box IP: 55, IP: 66	70
• 'BCH-SS' Stainless Steel	71
• Terminal Box IP:55 & IP:66	71
• Techno-Modular Enclosures	72

• Smartline TME	73
• Semi Modular Enclosures New	75
• TEOS Plus Enclosures New	76
• MCC, PCC & PMCC Bare Enclosures (Fixed & Draw-out Type)	77
• Control Desks	77
• IT Racks - 19" and ETSI Racks	78



Wires & Cables

• 3-Core Flat Cables for Submersible Pump Applications	82
• Single & Multi Core PVC Flexible Cables	83



Power Factor Control Products

• LT Power Capacitors	85
• Freedom Series Capacitor Duty Contactor	87
• Super Heavy Duty Capacitors, Detuned Reactors	88
• Thyristor Switched Module, Automatic Power Factor Controllers (APFC)	89
• & Intelligent Power Factor Controllers (IPFC)	89
• Digital Network Analysers	89
• APFC Panels	89



Motors

• High Efficiency Motors - General Purpose	90
• Premium Efficiency Motors - General Purpose	90
• High Efficiency Motors - Inverter Duty	90
• Premium Efficiency Motors - Inverter Duty	90



Automation Products

• AC Drives	92
• Digital DC Drives	93
• Programmable Logic Relay	93
• Soft Starters	94
• e-prox Proximity Sensors	95
• Plug-in Relays	99
• Electronic Timers	101



Custom Built Products

• MCC & PCC	103
• Crane Control Panels	104
• Punch Grid Resistors & Panels, NGR & DBR	105
• Special Purpose Starters	106
• Power Receptacles	107
• Auto Transformer Starters	108

Tough Rugged & Reliable

Miniature Circuit Breaker

- Line load interchangeability
- Suitable for isolation
- Suitable for IT systems
- Current limiting design
- 45mm panel cutout, suitable for standard MCB distribution boards
- Possibility of bus bar termination at both ends



**BCH
ELECTRIC
LIMITED**

Corporate Office : 1105, New Delhi House, 27, Barakhamba Road, New Delhi - 110 001 Tel. : 91-11-23316029/3610/6539/43673100 Fax : 91 11 23715247
E-mail : marketing@bchindia.com • www.bchindia.com



Registered Office : Block 1E, 216, Acharya Jagadish Chandra Bose Road, Kolkata - 700 017

Works 1 : 20/4, Mathura Road, Faridabad - 121 006 (Haryana) Tel. : 0129-4063000/4293000 Fax : 0129-2304024

Works 2 : 64-68, Sector-7, IIE, Pant Nagar, Rudrapur, Udham Singh Nagar - 263 153 (Uttarakhand) Tel. : 05944-250214/16 Fax : 05944-250215

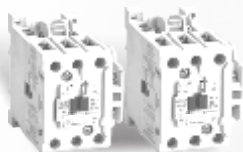
Low Voltage Switch Gear & Control Gear Products



- Air Circuit Breakers
- MCCBs
 - Resilient, Tembreak 2
- MCB, Isolator, MCB Distribution Boxes, RCCB 
- FSU, SDFU
- AC Contactors
- DC Contactors
- Solid State Relays
- Overload Relays
- Vacuum Contactors 
- Electronic Overcurrent Relays (BOCR)
- Motor Protection Circuit Breakers (MPCB)
- Limit Switches
- Push Buttons, Indicating Lights, LEDs
- Foot Switches
- AC Solenoids & Brakes
- DC Brakes
- Plugs & Sockets
- Plug & Socket Boxes
- Rewireable Fuse Switches
- Pneumatic Timers
- Motor Starters
 - DOL
 - Mini Manual
 - Star Delta
 - Spares-Motor Starters & Supmersible Pump Starters
- Submersible Pump Starters
 - Three Phase (DOL and Star Delta)
 - Single Phase
- Oil Immersed Starters

Air Circuit Breakers..... BCH

TemPower - 2 Range of Air Circuit Breakers

HSN Code : 8536

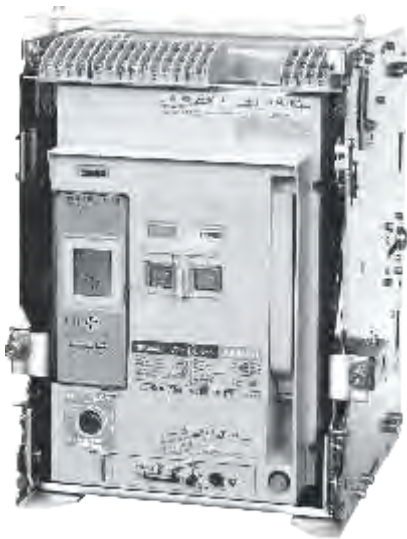

@ ACBs with higher breaking capacity and higher current ratings are also available On Request
MF: Manual Fixed Breaker, EF: Electrical Fixed Breaker
MDO : Manual Draw out, EDO : Electrical Draw out

Releases

TemPower2 provides positive protection for electric power systems.

The TemPower2 Series is equipped with an RMS sensing over-current release (OCR) having a wide range of protection function and capabilities.

Frame	Current rating (A)	Poles	Breaking capacity (Icu=Ics=Icw for 1 sec)	MRP [₹]			
				Fixed Breaker		Draw out breaker	
				MF	EF	MDO	EDO
AR208S	800A	3 4	65kA	On request			
AR212S	1250A	3 4	65kA				
AR216S	1600A	3 4	65kA				
AR220S	2000A	3 4	65kA				
AR325S	2500A	3 4	85kA				
AR332S	3200A	3 4	85kA				
AR440S	4000A	3 4	100kA				
AR650S	5000A	3 4	100kA				
AR663S	6300A	3 4	100kA				

*Standard MRP, means a standard breaker with

- A) Auxiliary Switch (4 change over)
 - B) Closing coil (In case of Motorised ACBs)
 - C) 1 No Draw out handle (in case of draw out ACB)
 - D) Terminations are standard as per : Horizontal : Upto (AR216S)
Vertical : (AR220S, AR325S, AR332S, AR440S, AR650S and AR663S)
 - E) Calibration : 40° C
 - F) Neutral CT is required to be ordered when Ground Fault option is required in the release (example AGR11BL-GL)
- Note : Above price is with over current release (OCR) Type AGR-11BL-AL with standard Functions LSI
Long Time (L), Short Time (S) and Instantaneous (I)

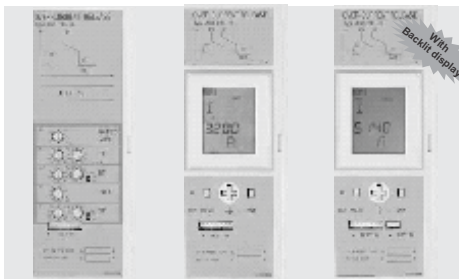

Standard OCR with adjustment dial Type AGR-11B. Standard OCR with LCD-'Ammeter' Type AGR-21B, 22B. Enhanced OCR with LCD-'Analyser' Type AGR-31B.

- For General Feeder circuits (L Characteristics)
- For General Feeder circuits (R Characteristics)
- For Generator protection (S Characteristics)

Protection features

Standard

- Long time delay
- Short time delay
- Instantaneous

Optional

- Ground fault
- Reverse Power trip

- N-phase protection
- Earth leakage
- Two channel pre trip
- Advance LCD display
- Contact temperature monitoring
- Communication protocol
- Phase rotation protection

For prices contact our nearest sales office.

Please note that the price of the ACBs mentioned above is only indicative,

to get an actual quote please fill in the ACB Ordering form provided overleaf **HSN Code : 8538**

Over current releases (OCR)	Functions	MRP [₹]
AGR-11BL-GL	LSIG*	On Request
AGR-21BL-PS	LSI with LCD display	On Request
AGR-21BL-PG	LSIG with LCD & Communication	On Request
AGR-31BL-PS	LSI with LCD display with energy metering, earth leakage and PTA	On Request
AGR-31BL-PG	LSIG with LCD display with energy metering, earth leakage and PTA	On Request
AGR-21BR-PS	LSI with LCD display with current metering and PTA	On Request
AGR-21BR-PG	LSIG with LCD display with current metering and PTA	On Request

* When using a 3 Pole ACB in a 3 phase 4 wire system, additional Neutral CT is required for OCR type AGR-11BL-GL

All accessories and spares like SHUNT, CLOSING, UNDER VOLTAGE release, castle lock, safety shutter, door interlock, motor charging units, etc. are available on request

* For more details refer product catalogue

HSN Code : 8536

Frame 1

- High Performance Compact Size
- Suitability for Isolation
- Rated at 50° C
- Line Load Interchangeability
- Double Insulation
- Thermal Magnetic Trip unit



Frame -1 :
 $I_{cu}/I_{cs} = 10/7.5, 15/15, 25/25, 30/15, 36/18, 50/25, 50/50$ kA

Frame 2

- High Performance Compact Size
- Suitability for Isolation
- Rated at 50° C
- Line Load Interchangeability
- Double Insulation
- Thermal Magnetic Trip unit



Frame -2 :
 $I_{cu}/I_{cs} = 25/25, 36/18, 36/27, 36/36, 50/25, 50/50$ kA

I_{cu} (Overload Setting)	Rated Current	Cat. No.	MRP [₹]
10kA @ (Fixed)	100, 80	XFE***G#	1820
	63, 50, 40, 32, 25, 20, 16	XFE***G	1670
15kA ~ (Fixed)	100, 80	XFN***P#	3700
	63, 50, 40, 32, 25, 20, 16	XFN***P	3700
25kA ~ (Adjustable)	100, 80	XFS***PV#	5500
	63, 50, 40, 32, 25, 20, 16	XFS***PV	5400
30kA ^ (Adjustable)	100, 80	XFH***NV#	4350
	63, 50, 40, 32, 25, 20, 16	XFH***NV	4350
36kA ^ (Adjustable)	100, 80	XFL***NV#	5100
	63, 50, 40, 32, 25, 20, 16	XFL***NV	4900
50kA ^ (Adjustable)	100, 80	XFV***NV#	8950
	63, 50, 40, 32, 25, 20, 16	XFV***NV	8500
50kA ~ (Adjustable)	100, 80	XFV***PV#	9200
	63, 50, 40, 32	XFV***PV	9000

XFE series with RAL-7035 (Light Grey) front Facia
 Other series with RAL-7016 (Dark Grey) front Facia

~ means $I_{cs} = 100\% I_{cu}$
 @ means $I_{cs} = 75\% I_{cu}$
 ^ means $I_{cs} = 50\% I_{cu}$

Code - Current Rating

Rating	16A	20A	25A	32A	40A	50A	63A	80A	100A
*Code	016	020	025	032	040	050	063	080	100

I_{cu} Overload Setting	Rated Current	Cat No.	MRP [₹]
25kA ~ Adjustable	250	XF2E250PV#	16700
	200	XF2E200PV#	12500
	160	XF2E160PV	9900
	125	XF2E125PV	8000
36kA ^ Adjustable	250	XF2N250NV#	12000
	200	XF2N200NV#	10450
	160	XF2N160NV	8050
	125	XF2N125NV	7100
36kA @ Adjustable	250	XF2N250GV#	17580
	200	XF2N200GV#	16230
	160	XF2N160GV	11590
	125	XF2N125GV	9085
36kA ~ Adjustable	250	XF2N250PV#	18500
	200	XF2N200PV#	17050
	160	XF2N160PV	12700
	125	XF2N125PV	9720
50kA ^ Adjustable	250	XF2H250NV#	18500
	200	XF2H200NV#	17150
	160	XF2H160NV	12850
	125	XF2H125NV	9855
50kA ~ Adjustable	250	XF2H250PV#	20770
	200	XF2H200PV#	19000
	160	XF2H160PV	15800
	125	XF2H125PV	13200

Complete range RAL-7016 (Dark Grey) front Facia

~ means $I_{cs} = 100\% I_{cu}$
 @ means $I_{cs} = 75\% I_{cu}$
 ^ means $I_{cs} = 50\% I_{cu}$

Spreader Link available as standard (for MCCB without spreader, please contact our sales team)

All above MCCBs have fixed (non adjustable) Magnetic setting

MCCBs with different I_{cu}/I_{cs} combination can be made available On Request

For MCCBs with 'Magnetic only' protection, prices available On Request.

All needed accessories are mentioned on page no 4
 (Extended terminals for all ratings is also available as accessory)

* For more details refer product catalogue



Frame -3 :
 $I_{cu}/I_{cs} = 36/36, 50/50 \text{ kA}$
 (Spreader terminal available by default)

Spreader Link available as standard (for MCCB without spreader, please contact our sales team)
 MCCBs with different I_{cu} / I_{cs} combination can be made available On Request
 For MCCBs with 'Magnetic only' protection, prices available On Request.



Frame 3

- High Performance Compact Size
- Suitability for Isolation
- Rated at 50° C
- Line Load Interchangeability
- Double Insulation
- Thermal Magnetic Trip Unit (TMTU)
 - Overload Setting: 0.8-1.0 In
 - Short Circuit Setting: 6-10 In

HSN Code : 8536

I_{cu} (Overload Setting)	Rated Current	Cat. No.	MRP [₹]
36kA ~ (Adjustable)	630	XF3N630PV	29000
	500	XF3N500PV	26600
	400	XF3N400PV	24540
	320	XF3N320PV	23380
50kA ~ (Adjustable)	630	XF3H630PV	30600
	500	XF3H500PV	29315
	400	XF3H400PV	25990
	320	XF3H320PV	24635

~ means $I_{cs} = 100\% I_{cu}$

- Electronic Trip Unit (ETU)-LSIG
 - Overload Setting: 0.4-1.0 In
 - Short Circuit Delay: 50-500 ms
 - Short Circuit Setting: 1.5-10 In
 - Earth Fault Delay: 50-500 ms
 - Earth Fault Setting: 0.2-0.55 In
 - Pre Trip Alarm Indication
 - Instantaneous Setting: 12 In

HSN Code : 8536

I_{cu} (Overload Setting)	Rated Current	Cat. No.	MRP [₹]
36kA ~ (Adjustable)	630	XF3N630PE-LSIG	40300
	400	XF3N400PE-LSIG	37400
50kA ~ (Adjustable)	630	XF3H630PE-LSIG	43000
	400	XF3H400PE-LSIG	38880

~ means $I_{cs} = 100\% I_{cu}$

ACCESSORIES FOR Resilient RANGE OF MCCBs
 HSN Code : 8538

Type	Product	Rating	Cat No.	MRP [₹]
Internal Accessories	Shunt Release	220V - 415V F1	XFSHT220V	1135
		220V - 415V F2	XF2SHT220V	1135
		220V - 415V F3	XF3SHT220V	1890
	Under Voltage Release	240V F1	XFUV240VA	1500
		240V F2	XF2UV240VA	1525
		240V F3	XF3UV240VA	2365
		415V F1	XFUV415VA	1735
		415V F2	XF2UV415VA	1735
		415V F3	XF3UV415VA	2365
	Auxiliary Contacts	1 C/O + 1 C/O	XFALAX11	1240
2 C/O		XFAX2	1240	

HSN Code : 8538

Type	Product	Rating	Cat No.	MRP [₹]	
External Accessories	Din Rail	F1	F1DIN	170	
		Extended Rotary Handle	F1	F1ROHE	1530
			F2	F2ROHE	1580
	F3		F3ROHE	3310	
	Extended Terminals	F1	ACMF1TP100	310	
		F2	ACMF2TP250	1135	
		Phase Barriers	F1	F1PB	65
	F2		F2PB	165	
	F3		F3PB	195	

HSN Code : 8536

Type	Product	Rating	Cat No.	MRP [₹]
External Accessories	MCCB Enclosure	F1	F1EU3P	755
		F2	F2EU3P	1490

* For more details refer product catalogue

Effective from 06.06.2019



- Line load interchangeability
- Suitable for isolation
- Suitable for IT systems
- Current limiting design
- Possibility of bus bar termination at both ends
- 45mm panel cutout, suitable for standard MCB distribution boards



Pole	Standard pack of	Rating	B Curve Cat. No.	MRP (per unit) [₹]	C Curve Cat. No.	MRP (per unit) [₹]
1P	12 units	6A	BCHX10SPB06	212	BCHX10SPC06	215
		10A	BCHX10SPB10	212	BCHX10SPC10	215
		16A	BCHX10SPB16	212	BCHX10SPC16	215
		20A	BCHX10SPB20	212	BCHX10SPC20	215
		25A	BCHX10SPB25	212	BCHX10SPC25	215
		32A	BCHX10SPB32	212	BCHX10SPC32	215
		40A	BCHX10SPB40	475	BCHX10SPC40	495
		50A	BCHX10SPB50	475	BCHX10SPC50	495
1P + N	6 units	6A			BCHX10SNC06	645
		10A			BCHX10SNC10	645
		16A			BCHX10SNC16	645
		20A			BCHX10SNC20	645
		25A			BCHX10SNC25	645
		32A			BCHX10SNC32	645
		40A			BCHX10SNC40	900
		50A			BCHX10SNC50	900
2P	6 units	6A	BCHX10DPB06	665	BCHX10DPC06	675
		10A	BCHX10DPB10	665	BCHX10DPC10	675
		16A	BCHX10DPB16	665	BCHX10DPC16	675
		20A	BCHX10DPB20	665	BCHX10DPC20	675
		25A	BCHX10DPB25	665	BCHX10DPC25	675
		32A	BCHX10DPB32	665	BCHX10DPC32	675
		40A	BCHX10DPB40	1060	BCHX10DPC40	1085
		50A	BCHX10DPB50	1060	BCHX10DPC50	1085
3P	4 units	6A	BCHX10TPB06	1075	BCHX10TPC06	1090
		10A	BCHX10TPB10	1075	BCHX10TPC10	1090
		16A	BCHX10TPB16	1075	BCHX10TPC16	1090
		20A	BCHX10TPB20	1075	BCHX10TPC20	1090
		25A	BCHX10TPB25	1075	BCHX10TPC25	1090
		32A	BCHX10TPB32	1075	BCHX10TPC32	1090
		40A	BCHX10TPB40	1600	BCHX10TPC40	1630
		50A	BCHX10TPB50	1600	BCHX10TPC50	1630
3P + N	3 units	6A			BCHX10TNC06	1390
		10A			BCHX10TNC10	1390
		16A			BCHX10TNC16	1390
		20A			BCHX10TNC20	1390
		25A			BCHX10TNC25	1390
		32A			BCHX10TNC32	1390
		40A			BCHX10TNC40	1880
		50A			BCHX10TNC50	1880
4P	3 units	6A	BCHX10FPB06	1480	BCHX10FPC06	1495
		10A	BCHX10FPB10	1480	BCHX10FPC10	1495
		16A	BCHX10FPB16	1480	BCHX10FPC16	1495
		20A	BCHX10FPB20	1480	BCHX10FPC20	1495
		25A	BCHX10FPB25	1480	BCHX10FPC25	1495
		32A	BCHX10FPB32	1480	BCHX10FPC32	1495
		40A	BCHX10FPB40	2130	BCHX10FPC40	2145
		50A	BCHX10FPB50	2130	BCHX10FPC50	2145
63A	BCHX10FPB63	2130	BCHX10FPC63	2145		

HSN Code : 8536



Poles	Standard Pack of	Rating	Cat. No.	MRP (per unit) [₹]
2P	6 units	40A	BCHISODP40	435
	6 units	63A	BCHISODP63	540
3P	4 units	40A	BCHISOTP40	820
	4 units	63A	BCHISOTP63	915
4P	3 units	40A	BCHISOFP40	940
	3 units	63A	BCHISOFP63	1025

MCB DISTRIBUTION BOXES



HSN Code : 8537



Description	No. of Modules (Incoming + Outgoing)	Single Door		Double Door	
		Cat. No.	MRP [₹]	Cat. No.	MRP [₹]
4 WAY, SPN DB	4	BCHSPNSD04W	721	BCHSPNDD04W	1213
6 WAY, SPN DB	6	BCHSPNSD06W	742	BCHSPNDD06W	1250
8 WAY, SPN DB	8	BCHSPNSD08W	912	BCHSPNDD08W	1469
12 WAY, SPN DB	12	BCHSPNSD12W	1195	BCHSPNDD12W	1965
16 WAY, SPN DB	16	BCHSPNSD16W	1533	BCHSPNDD16W	2515

HSN Code : 8537



Description	No. of Modules (Incoming + Outgoing)	Single Door		Double Door	
		Cat. No.	MRP [₹]	Cat. No.	MRP [₹]
4 WAY, HTPN DB	8+12	BCHHTPNSD04W	2338	BCHHTPNDD04W	3166
6 WAY, HTPN DB	8+18	BCHHTPNSD06W	2807	BCHHTPNDD06W	3949
8 WAY, HTPN DB	8+24	BCHHTPNSD08W	3078	BCHHTPNDD08W	4901
12 WAY, HTPN DB	8+36	BCHHTPNSD12W	4102	BCHHTPNDD12W	7022

HSN Code : 8537

Description	Cat. No.	No. of Modules (Incoming + Outgoing)	MRP [₹]
4 WAY, DD, MCB I/C, VERTICAL TPN DB	BCHVTPNDD04W-A	8+12	6561
6 WAY, DD, MCB I/C, VERTICAL TPN DB	BCHVTPNDD06W-A	8+18	7766
8 WAY, DD, MCB I/C, VERTICAL TPN DB	BCHVTPNDD08W-A	8+24	9033
12 WAY, DD, MCB I/C, VERTICAL TPN DB	BCHVTPNDD12W-A	8+36	11536

All above DB's are double door

MCB DISTRIBUTION BOXES BCH

HSN Code : 8537



Description	Cat. No.	No. of Modules (Incoming + Outgoing)	MRP [₹]
4 WAY, DD, 125A, MCCB I/C, VERTICAL TPN DB	BCHVTPNDD04W-B		9400
8 WAY, DD, 125A, MCCB I/C, VERTICAL TPN DB	BCHVTPNDD08W-B		11450
12 WAY, DD, 125A, MCCB I/C, VERTICAL TPN DB	BCHVTPNDD12W-B		14600
4 WAY, DD, 250A, MCCB I/C, VERTICAL TPN DB	BCHVTPNDD04W-C		11250
8 WAY, DD, 250A, MCCB I/C, VERTICAL TPN DB	BCHVTPNDD08W-C		14000
12 WAY, DD, 250A, MCCB I/C, VERTICAL TPN DB	BCHVTPNDD12W-C		16350

All above DB's are double door

HSN Code : 8537



Description	Cat. No.	No. of Modules (Incoming + Outgoing)	MRP [₹]
4 WAY, DD, 7 SEGMENT PHASE SEGREGATED DB	BCHPHSGDD04W	8+12+12	10390
6 WAY, DD, 7 SEGMENT PHASE SEGREGATED DB	BCHPHSGDD06W	8+12+18	11710
8 WAY, DD, 7 SEGMENT PHASE SEGREGATED DB	BCHPHSGDD08W	8+12+24	13075
12 WAY, DD, 7 SEGMENT PHASE SEGREGATED DB	BCHPHSGDD12W	8+12+36	16618

All above DB's are double door

HSN Code : 8537



Description	Cat. No.	No. of Modules (Incoming + Outgoing)	MRP [₹]
4 WAY, 40A, DD, PHASE SELECTOR DB	BCHPHSLDD04W-40		13280
6 WAY, 40A, DD, PHASE SELECTOR DB	BCHPHSLDD06W-40		13335
8 WAY, 40A, DD, PHASE SELECTOR DB	BCHPHSLDD08W-40		15165
12 WAY, 40A, DD, PHASE SELECTOR DB	BCHPHSLDD12W-40		16315
4 WAY, 63A, DD, PHASE SELECTOR DB	BCHPHSLDD04W-63		13266
6 WAY, 63A, DD, PHASE SELECTOR DB	BCHPHSLDD06W-63		13573
8 WAY, 63A, DD, PHASE SELECTOR DB	BCHPHSLDD08W-63		14973
12 WAY, 63A, DD, PHASE SELECTOR DB	BCHPHSLDD12W-63		16590

All above DB's are double door

HSN Code : 8537



Description	Cat. No.	No. of Modules (Incoming + Outgoing)	MRP [₹]
2 ROW, 13 MODULE, DD, ROW DB	BCHROWDB2R13	13	4959
3 ROW, 13 MODULE, DD, ROW DB	BCHROWDB3R13	13	5845
4 ROW, 13 MODULE, DD, ROW DB	BCHROWDB4R13	13	6464

All above DB's are double door

HSN Code : 8537



Description	Cat. No.	No. of Modules (Incoming + Outgoing)	MRP [₹]
SPN-10A, P&S DB	BCHPSDBSPN10		991
SPN-20A, P&S DB	BCHPSDBSPN20		991
TPN-20A, P&S DB	BCHPSDBTPN20		2775
TPN-30A, P&S DB	BCHPSDBTPN30		2775

HSN Code : 8537



Description	Cat. No.	No. of Modules (Incoming + Outgoing)	MRP [₹]
SP, ONE WAY MCB DB	BCHOWMCBDBSP		375
DP, ONE WAY MCB DB	BCHOWMCBDBDP		375
TP, ONE WAY MCB DB	BCHOWMCBDBTP		433
FP, ONE WAY MCB DB	BCHOWMCBDBFP		433



RCCB, Double Pole

HSN Code : 8536

Description	Cat. No.	MRP [₹]
25A - 30mA	BCHRCB030DPC25	2670
40A - 30mA	BCHRCB030DPC40	2740
63A - 30mA	BCHRCB030DPC63	3675
25A - 100mA	BCHRCB100DPC25	2700
40A - 100mA	BCHRCB100DPC40	2800
63A - 100mA	BCHRCB100DPC63	3750
25A - 300mA	BCHRCB300DPC25	2700
40A - 300mA	BCHRCB300DPC40	3000
63A - 300mA	BCHRCB300DPC63	3750

All above RCCB's are 'AC' type



RCCB, Four Pole

HSN Code : 8536

Description	Cat. No.	MRP [₹]
25A - 30mA	BCHRCB030FPC25	3450
40A - 30mA	BCHRCB030FPC40	3550
63A - 30mA	BCHRCB030FPC63	4000
25A - 100mA	BCHRCB100FPC25	3550
40A - 100mA	BCHRCB100FPC40	3700
63A - 100mA	BCHRCB100FPC63	4000
25A - 300mA	BCHRCB300FPC25	3550
40A - 300mA	BCHRCB300FPC40	3720
63A - 300mA	BCHRCB300FPC63	4000

All above RCCB's are 'AC' type

Current Limiting Curve

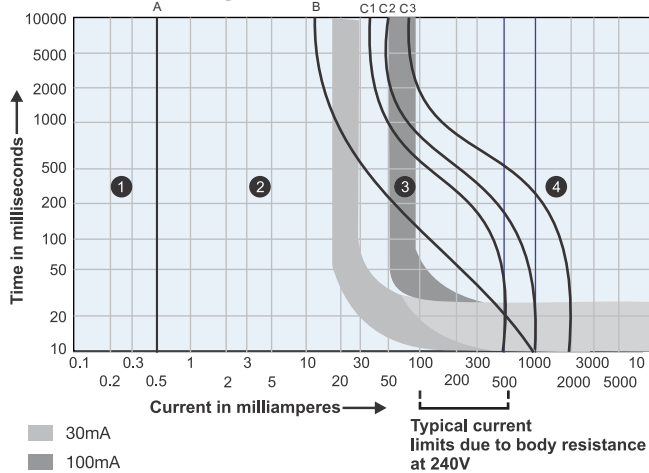

Effect of Current

Zone	Effects
Zone 1	Usually no reactions
Zone 2	Usually no harmful effects
Zone 3	Muscle cramps can occur. There is normally no danger of ventricular fibrillation.
Zone 4	Chances of ventricular fibrillation increased upto 5% (Curve C2) upto 50% (Curve C3) and above 50% beyond Curve C3. Effects such as cardiac arrest, breathing arrest and heavy burns may also occur.



Total Protection Complete Control

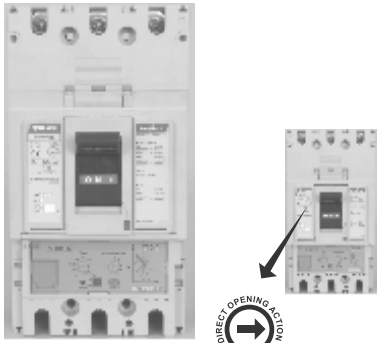

TemBreak



User friendly adjustment



Clear Trip Indication



OFF



ON



TRIP

Tembreak 2 MCCB with 10kA* breaking capacity

HSN Code : 8536

Frame	Pole	Current (A)	Type	Code	Cat. No.	MRP [₹]
E100SF	3	10-40	Fix-Thermal	■	XT2E100SF3F■U0	4995
	3	50-75	Fix-Thermal	■	XT2E100SF3F■U0	4995
	3	100	Fix-Thermal	A0	XT2E100SF3FA0U0	5255

* Ics = 50%

Tembreak 2 MCCB with 25kA* breaking capacity

HSN Code : 8536

Frame	Pole	Current (A)	Type	Code	Cat. No.	MRP [₹]
S160SCF	3	15-40	Fix-Thermal	■	XT2S160SCF3F■U0	5710
	4		Fix-Thermal	■	XT2S160SCF4F■U0	7995
	3	50-75	Fix-Thermal	■	XT2S160SCF3F■U0	5710
	4		Fix-Thermal	■	XT2S160SCF4F■U0	7995
	3	100	Fix-Thermal	A0	XT2S160SCF3FA0U0	5995
	4		Fix-Thermal	A0	XT2S160SCF4FA0U0	8390
	3	125	Fix-Thermal	AB	XT2S160SCF3FABU0	6385
	4		Fix-Thermal	AB	XT2S160SCF4FABU0	8805
S160SCJ	3	25-40	Adj-Thermal	■	XT2S160SCJ3F■U0	7930
	4		Adj-Thermal	■	XT2S160SCJ4F■U0	10580
	3	63-80	Adj-Thermal	■	XT2S160SCJ3F■U0	7930
	4		Adj-Thermal	■	XT2S160SCJ4F■U0	10580
	3	100	Adj-Thermal	A0	XT2S160SCJ3FA0U0	8330
	4		Adj-Thermal	A0	XT2S160SCJ4FA0U0	11105
	3	125	Adj-Thermal	AB	XT2S160SCJ3FABU0	8745
	4		Adj-Thermal	AB	XT2S160SCJ4FABU0	11660
	3	160	Adj-Thermal	AF	XT2S160SCJ3FAFU0	9175
	4		Adj-Thermal	AF	XT2S160SCJ4FAFU0	12250

*Ics = 50%

Code - Current Rating

Rating	15A	20A	30A	32A	40A	50A	60A	63A	75A	100A	125A	150A	160A	175A	200A	225A	250A	400A	630A	800A	1000A	1250A	1600A	2000A
■Code	15	20	30	32	40	50	60	63	75	A0	AB	AE	AF	AG	B0	BB	BE	D0	630	800	1000	1250	1600	2000

Plugin versions Available on request

* For more details refer product catalogue

Accessories are mentioned on page no 12

Total Protection Complete Control Tembreak 2 MCCB with 25kA* breaking capacity

HSN Code : 8536

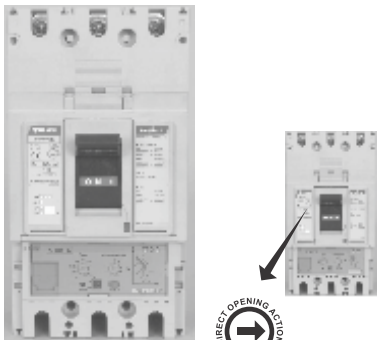

TemBreak



Frame	Pole	Current (A)	Type	Code	Cat. No.	MRP [₹]
E400NJ	3	250	Adj-Thermal	BE	XT2E400NJ3FBEU0	31060
	4		Adj-Thermal	BE	XT2E400NJ4FBEU0	41390
	3	400	Adj-Thermal	D0	XT2E400NJ3FD0U0	32600
	4		Adj-Thermal	D0	XT2E400NJ4FD0U0	43430

*Ics = 100%

User friendly adjustment



Tembreak 2 MCCB with 36kA* breaking capacity

HSN Code : 8536

Frame	Pole	Current(A)	Type	Code	Cat. No.	MRP [₹]
S250NJ	3	160	Adj-Thermal	AF	XT2S250NJ3FAFU0	18185
	4		Adj-Thermal	AF	XT2S250NJ4FAFU0	22185
	3	200	Adj-Thermal	B0	XT2S250NJ3FB0U0	18195
	4		Adj-Thermal	B0	XT2S250NJ4FB0U0	23130
	3	250	Adj-Thermal	BE	XT2S250NJ3FBEU0	19645
	4		Adj-Thermal	BE	XT2S250NJ4FBEU0	23320
S400CJ	3	400	Adj-Thermal	D0	XT2S400CJ3FD0U0	34170
	4		Adj-Thermal	D0	XT2S400CJ4FD0U0	45560
S800CJ	3	630	Adj-Thermal	630	XT2S800CJ3F630U0	51175
	4		Adj-Thermal	630	XT2S800CJ4F630U0	68240
	3	800	Adj-Thermal	800	XT2S800CJ3F800U0	53740
	4		Adj-Thermal	800	XT2S800CJ4F800U0	71645
S250NE	3	125	Electronic	AB	XT2S250NE3FABU0	46175
	4		Electronic	AB	XT2S250NE4FABU0	61565
	3	250	Electronic	BE	XT2S250NE3FBEU0	48485
	4		Electronic	BE	XT2S250NE4FBEU0	64650
E630NE	3	630	Electronic	630	XT2E630NE3F630U0	56940
	4		Electronic	630	XT2E630NE4F630U0	75920

*Ics = 100%

Clear Trip Indication



OFF



ON



TRIP

Code - Current Rating

Rating	15A	20A	30A	32A	40A	50A	60A	63A	75A	100A	125A	150A	160A	175A	200A	225A	250A	400A	630A	800A	1000A	1250A	1600A	2000A
Code	15	20	30	32	40	50	60	63	75	A0	AB	AE	AF	AG	B0	BB	BE	D0	630	800	1000	1250	1600	2000

Plugin versions Available on request

Accessories are mentioned on page no 12

* For more details refer product catalogue

Total Protection Complete Control

Tembreak 2 MCCB with 50kA* breaking capacity

HSN Code : 8536

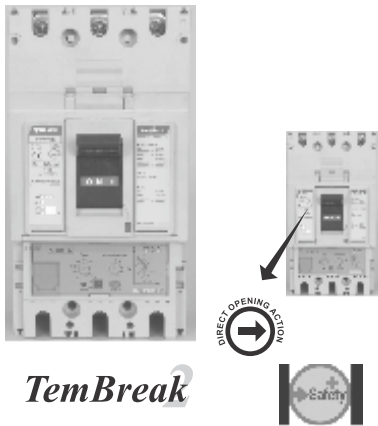

User friendly adjustment



Clear Trip Indication



OFF



ON



TRIP

Frame	Pole	Current (A)	Type	Code	Cat. No.	MRP [₹]
S400NF	3	125	Fix-Thermal	AB	XT2S400NF3FABU0	31645
	4		Fix-Thermal	AB	XT2S400NF4FABU0	42195
	3	160	Fix-Thermal	AF	XT2S400NF3FAFU0	32280
	4		Fix-Thermal	AF	XT2S400NF4FAFU0	43045
	3	200	Fix-Thermal	B0	XT2S400NF3FB0U0	32925
	4		Fix-Thermal	B0	XT2S400NF4FB0U0	43900
	3	225	Fix-Thermal	BB	XT2S400NF3FBBU0	32955
	4		Fix-Thermal	BB	XT2S400NF4FBBU0	43930
	3	250	Fix-Thermal	BE	XT2S400NF3FBEU0	33425
	4		Fix-Thermal	BE	XT2S400NF4FBEU0	44565
	3	320	Fix-Thermal	BF	XT2S400NF3FBFU0	33930
	4		Fix-Thermal	BF	XT2S400NF4FBFU0	45240
3	400	Fix-Thermal	D0	XT2S400NF3FD0U0	34445	
4		Fix-Thermal	D0	XT2S400NF4FD0U0	45925	
S800NF	3	630	Fix-Thermal	630	XT2S800NF3F630U0	55925
	4		Fix-Thermal	630	XT2S800NF4F630U0	74565
	3	800	Fix-Thermal	800	XT2S800NF3F800U0	57630
	4		Fix-Thermal	800	XT2S800NF4F800U0	76835
S400NJ	3	250	Adj-Thermal	BE	XT2S400NJ3FBEU0	33460
	4		Adj-Thermal	BE	XT2S400NJ4FBEU0	44615
	3	400	Adj-Thermal	D0	XT2S400NJ3FD0U0	35885
	4		Adj-Thermal	D0	XT2S400NJ4FD0U0	47840
S800NJ	3	630	Adj-Thermal	630	XT2S800NJ3F630U0	56335
	4		Adj-Thermal	630	XT2S800NJ4F630U0	75110
	3	800	Adj-Thermal	800	XT2S800NJ3F800U0	59120
	4		Adj-Thermal	800	XT2S800NJ4F800U0	78825
S400NE	3	250	Electronic	BE	XT2S400NE3FBEU0	51775
	4		Electronic	BE	XT2S400NE4FBEU0	69035
	3	400	Electronic	D0	XT2S400NE3FD0U0	54365
	4		Electronic	D0	XT2S400NE4FD0U0	72480
S630CE	3	630	Electronic	630	XT2S630CE3F630U0	57795
	4	630	Electronic	630	XT2S630CE4F630U0	76045
S800NE	3	800	Electronic	800	XT2S800NE3F800U0	75335
	4	800	Electronic	800	XT2S800NE4F800U0	100440
S1000SE	3	1000	Electronic	1000	XT2S1000SE3F1000U0	90410
	4	1000	Electronic	1000	XT2S1000SE4F1000U0	120660
S1250SE	3	1250	Electronic	1250	XT2S1250SE3F1250U0	135660
	4	1250	Electronic	1250	XT2S1250SE4F1250U0	180890
S1600SE	3	1600	Electronic	1600	XT2S1600SE3F1600U0	183155
	4	1600	Electronic	1600	XT2S1600SE4F1600U0	244205

*Ics = 100%

Code - Current Rating

Rating	15A	20A	30A	32A	40A	50A	60A	63A	75A	100A	125A	150A	160A	175A	200A	225A	250A	400A	630A	800A	1000A	1250A	1600A	2000A
Code	15	20	30	32	40	50	60	63	75	A0	AB	AE	AF	AG	B0	BB	BE	D0	630	800	1000	1250	1600	2000

* For more details refer product catalogue

Note : MCCB's upto 2000A rating & 200KA breaking capacity available on request. Plug in versions available on request.

ACCESSORIES *TemBreak* MCCB..... BCH

ACCESSORIES FOR TEMBREAK-2 RANGE OF MCCB

HSN Code : 8538



Motor Operator

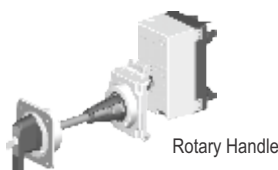

Rotary Handle

Type	Description	up to 125A	250A	400A & 630A	MRP [₹]
Aux Switch	1 Change over	T2AX00M3SWA			1615
Alarm Switch	1 Change over	T2AL00M3SWA			1615
Shunt Release	100-120VAC	T2SH00A10WA			4120
Shunt Release	200-240VAC	T2SH00A20WA			3745
Shunt Release	380-450VAC	T2SH00A40WA			4410
UV Release	200-240VAC	T2UV00A20NWA			5430
UV Release	380-450VAC	T2UV00A40NWA			5430
Motor Operator	110VAC	T2MC12A10NA	T2MC25A10NA		On Request
Motor Operator	220VAC	T2MC12A20NA	T2MC25A20NA		On Request
Motor Operator	240VAC	T2MC12A24NA	T2MC25A24NA		On Request
Motor Operator	100-240VAC			T2MC40A10NA	On Request
Rotary Handle	Panel Mounted (Ip54)	T2HP12R5BNA			7365
Rotary Handle	Panel Mounted (Ip54)		T2HP25R5BNA		10240
Rotary Handle	Panel Mounted (IP54)			T2HP40R5BNA	12155

Extended Terminals for All TEMBREAK-2 MCCBs

HSN Code : 8538

Frame	For	Cat. No.	MRP [₹]
125A FRAME	3 Pole	ACMTP1253	695
	4 Pole	ACMTP1254	980
160A/250A FRAME	3 Pole	ACMTP2503	1035
	4 Pole	ACMTP2504	1780
400A FRAME	3 Pole	ACMTP4003	2730
	4 Pole	ACMTP4004	3150

One set = 6 Nos. Links for 3 Pole MCCBs
One set = 8 Nos. Links for 4 Pole MCCBs

* For more details refer product catalogue

Switch Disconnecter Fuse Units



Suitable for DIN / BOLTED fuses in open execution

HSN Code : 8536

Rating (A) AC-23A	Cat No.	Fuse Type	Type	MRP [₹]
32A	PSFS323ND00	DIN	TPN	1830
32A	PSFS323ND000	DIN	TPN	1830
32A	PSFS323NB	Bolted	TPN	1830
32A	PSFS323B	Bolted	TP	1785
63A	PSFS633ND00	DIN	TPN	2530
63A	PSFS633ND000	DIN	TPN	2530
63A	PSFS633NB	Bolted	TPN	2530
63A	PSFS633B	Bolted	TP	2455
100	PSFS1003*	DIN/Bolted	TP	4735
100	PSFS1003N*	DIN/Bolted	TPN	4960
125	PSFS1253*	DIN/Bolted	TP	6260
125	PSFS1253N*	DIN/Bolted	TPN	6715
160	PSFS160*	DIN/Bolted	TP	6880
160	PSFS1603N*	DIN/Bolted	TPN	7475
200	PSFS2003B	Bolted	TP	8585
200	PSFS2003NB	Bolted	TPN	8815

* Use suffix 'D' for DIN type, 'B' for bolted type

Switch Disconnecter

HSN Code : 8536

Rating (A) AC-23A	Cat No.	Fuse Type	Type	MRP [₹]
32A	PSSD323N	-	TPN	1665
63A	PSSD633N	-	TPN	2295
100A	PSSD1003N	-	TPN	4520
125A	PSSD1253N	-	TPN	5615
160A	PSSD1603N	-	TPN	6325
200A	PSSD2003N	-	TPN	7145

Fuse Switch Units Type FS

HSN Code : 8538

Rating (A) AC-23A	Cat No.	Fuse Type	Type	MRP [₹]
32A	FS0N	BOLTED	TP	1860
63A	FS1N	BOLTED	TP	2540
Shroud	AC21TS			160
1NO+1NC	AC21EB11	for FS0 / FS1N		475
Neutral	AC21L	for FS0 / FS1N-		210
Handle assembly-32A	SP21FS0H	for FS0		310
Handle assembly-63A	SP21FS1H	for FS1		310

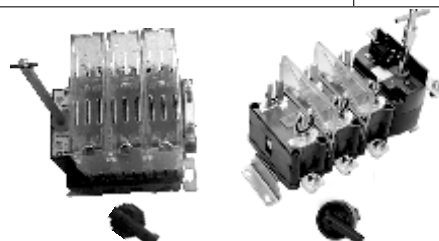

Switch Disconnecter Fuse

- Conforms to IS 13947-3
- TPN/TP version
- AC 23A duty
- Mechanism with 4 Breaks per pole
- Handle with door interlock and padlock



Controlgear

- DUROS FREEDOM CONTACTORS
- DEFINITE PURPOSE CONTACTORS
- CAP DUTY CONTACTORS
- AGRI CONTACTORS
- CITATION SERIES 3 POLE
- VACUUM CONTACTORS

- **Contactors**
- **Overload Relay**
- **Electronic Over Current Relay**
- **Motor Protection Circuit Breaker**
- **Solid State Relay**
- **Push Buttons & Indicating Lights**

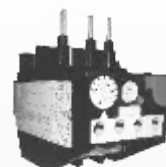
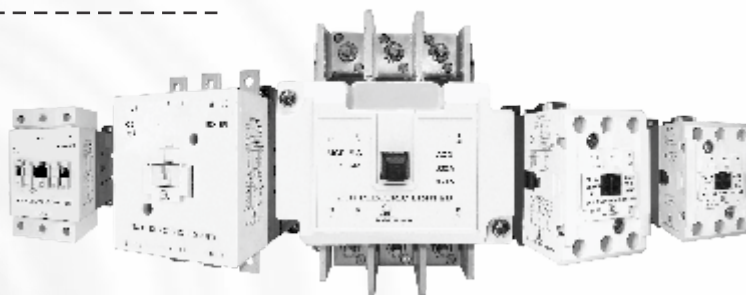
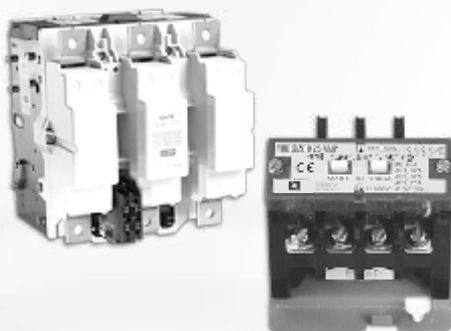

DUROS FREEDOM RANGE

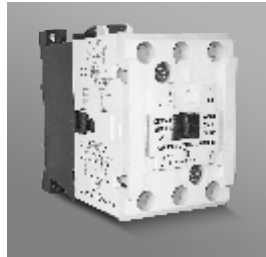

- Conforms to IEC 60947-4-1 / IS 13947
- No derating upto -20°C to 60°C
- 3 Pole and 4 Pole versions
- Widest Range from 6A to 1200A in 7 frame sizes
- Snap Open design for easy inspection
- Self Lifting Screws for quick termination
- Superior grade material with high temperature withstand
- : Ideal for stringent duty applications
- Most compact design
- Low VA burden coils
- Successfully tested for Type - 2 coordination

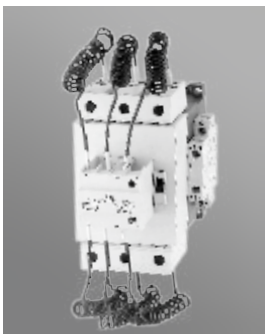
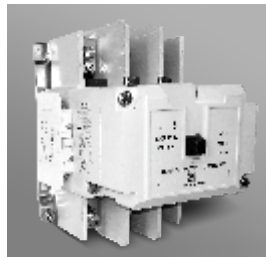

- Range : 5 to 60 KVAR
- Enhanced equipment life
- Compact design
- Conforms to IEC 60947-4-1 & IS 13947-4-1 (AC-6b) utilization category



Design Flexibility

Interlocking 2 Different frames using a common Mechanical Interlock (Upto 75A)



BCH Series : 400A to 1200A

- Conforms to IEC60947-4-1 / IS 13947
- Insulation voltage upto 1000V
- Universal Control : Same coil for AC and DC Supply
- Delayed Drop Off feature for networks with transient power problem ensuring continuity of power supply
- Special magnet design for reduced shock and vibration
- Front open design for ease of inspection



Contactors BCH

Duros Freedom Series 3 Pole AC Control

HSN Code : 8536

Size	AC1 Rating	AC3 Rating 415 V			Aux. Contact	Cat. No.	MRP [₹]	Lot Size
		A	HP	KW				
A	20	6	3	2.2	1NO	CE15ANS3 ■ B-N	840	1
					1NC	CE15ANC3 ■ B-N		
B	20	9.1	5.5	4	1NO	CE15BNS3 ■ B-N	910	
					1NC	CE15BNC3 ■ B-N		
C	20	12	7.5	5.5	1NO	CE15CNS3 ■ B-N	1040	
					1NC	CE15CNC3 ■ B-N		
D	32	16	10	7.5	1NO	CE15DN3. ■ B10-N	1165	
					1NC	CE15DN3. ■ B01-N		
	32	18	10	7.5	1NO	CE15D1N3. ■ B10-N	1175	
					1NC	CE15D1N3. ■ B01-N		
E	40	25	15	11	1NO	CE15EN3. ■ B10-N	1640	
					1NC	CE15EN3. ■ B01-N		
F	40	32	20	15	1NO	CE15FN3. ■ B10-N	3290	
					1NC	CE15FN3. ■ B01-N		
G	60	40	30	22	1NO+1NC	CE15GN3 ■	4890	
					-	CE15GN3 ■ NB	4630	
H	75	50	33.5	25	1NO+1NC	CE15HN3 ■	6100	
					-	CE15HN3 ■ NB	5860	
J	80	65	50	37	1NO+1NC	CE15JN3 ■	8300	
					-	CE15JN3 ■ NB	8060	
K	80	73	50	37	1NO+1NC	CE15KN3 ■	8520	
					-	CE15KN3 ■ NB	8250	
	80	75	50	37	1NO+1NC	CE15K1N3 ■	8600	
					-	CE15K1N3 ■ NB	8300	
K-1	115	80	53	40	1NO+1NC	BCH15KT.3.11. ■	10140	
L	125	95	62	47	1NO+1NC	BCH15LT.3.11. ■	12250	
M	135	110	80	60	1NO+1NC	BCH15MT.3.11. ■	15050	
N	230	150	100	75	1NO+1NC	BCH15NT.3.11. ■	20020	
P	250	175	125	95	1NO+1NC	BCH15PT.3.11. ■	24950	
R	300	200	150	100	1NO+1NC	MCE15RN3 ■ 7	27900	
S0	315	265	186	140	1NO+1NC	MCE15S0N3 ■ 7	34550	
S	315	300	220	160	1NO+1NC	MCE15SN3 ■ 7	38150	

■ For Coil Voltage Codes refer Table on page 24

Duros Freedom Series 3 Pole AC/DC Control

HSN Code : 8536

Size	AC1 Rating(A)	AC3 Rating 415 V			Aux. Contact	Cat. No.	MRP [₹]
		A	HP	KW			
BCH54	600	400	320	240	2NO+2NC	BCH54.3.22. ■	48950
BCH55	600	450	320	240	2NO+2NC	BCH55.3.22. ■	62950
BCH57	760	550	420	315	2NO+2NC	BCH57.3.22. ■	70950
BCH62	1000	700	533	400	2NO+2NC	BCH62.3.22. ■	134640
BCH64	1000	860	666	500	2NO+2NC	BCH64.3.22. ■	219300
BCH76	1200	1000	800	600	1NO+2NC	BCH76.3.12. ■	409010
BCH78	1350	1200	933	700	1NO+2NC	BCH78.3.12. ■	433500

■ For Coil Voltage Codes refer Table on page 24

For DC control circuit of contactor size BCH76/BCH78 add Rs.2600

Duros Freedom series 4 Pole contactors (AC Control)

- 100% rated add-on 4th pole for flexibility (32A to 80AAC1)
- Low energy consumption

HSN Code : 8536



AC1 Rating (A)	Cat. No.	MRP [₹]
20	CE15CN4 ■ B-N	1285
32	CE15DN4 ■-N	1345
40	CE15EN4 ■-N	2030
60	CE15GN4 ■	4890
75	CE15HN4 ■	6495
80	CE15JN4 ■	7475
200	BCH15MN.4.11.■	18575
250	BCH15NN.4.11.■	20515
300	BCH15PN.4.11.■	36735

Contactor : 3 Pole DC Control Type CE15

HSN Code : 8536

Common Accessories 'upto 73A'

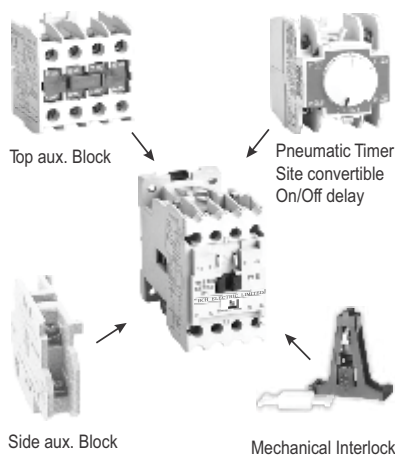

AC3 (A) at 415VAC	KW	Aux Contact	Cat No.	MRP [₹]
6	2.2	-	CE15ANC3■-N CE15ANS3■-N	1235
9	4.4	-	CE15BNC3■-N CE15BNS3■-N	1345
12	5.5	-	CE15CNC3■-N CE15CNS3■-N	1410
16	7.5	-	CE15DN3■-N	1710
25	11	-	CE15EN3■-N	2290
32	15	-	CE15FN3■-N	4860
40	22	-	CE15GN3 ■	5750
50	25	-	CE15HN3 ■	7340
65	37	-	CE15JN3 ■	8735
73	37	-	CE15KN3 ■	10285
75	37	-	CE15K1N3 ■	10285

■ For Coil Voltage Codes refer Table on page 24

Pure DC Duros Freedom Series 3 Pole DC Control Type CE16

HSN Code : 8536

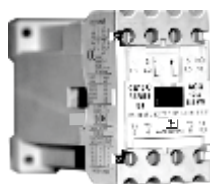

DC Control

- Standard voltages 24VDC , 110VDC , 220VDC

AC3 (A) at 415VAC	KW	Aux Contact	Cat No.	MRP [₹]
9.1	4	1NO 1NC	CE16BNS3*B CE16BNC3*B	1400
12	5.5	1NO 1NC	CE16CNS3*B CE16CNC3*B	1470
16	7.5	1NO+1NC	CE16DN3*B	1795
25	11	1NO+1NC	CE16EN3*B	2450
32	15	1NO+1NC	CE16FN3*B	5115

*Coil Codes :
DC control

24V	U1
48V	W1
110V	A1
220V	B1
60V	X1
125V	E1



Pure DC

Control Relay HSN Code : 8536

Aux Contact	Cat No.	MRP [₹]
2NO+2NC	D16CR22*	1520
3NO+1NC	D16CR31*	
4NO	D16CR40*	

*Coil Codes : DC control

24V	48V	110V	220V	60V
U1	W1	A1	B1	X1

Control Relays Freedom Series HSN Code : 8536

Size	Contact Configuration	Cat No.	MRP [₹]		Lot Size
			AC	DC	
CR	2NO+2NC 3NO+1NC 4NO	D15CR22 ■-N D15CR31 ■-N D15CR40 ■-N	980	1520	1

■ For Coil Voltages Codes refer Table on page 24



Freedom series Capacitor duty contactor (AC Control)

HSN Code : 8536

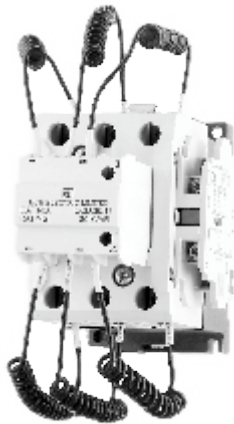

kVAR rating at 415V 3Ph 50Hz	Cat No.	Aux Contacts	MRP [₹]
5	CCD.05.11.■	1NO+1NC	1915
10	CCD.10.11.■	1NO+1NC	2085
15	CCD.15.11.■	1NO+1NC	3045
20	CCD.20.11.■	1NO+1NC	3570
25	CCD.25.11.■	1NO+1NC	4080
30	CCD.30.11.■	1NO+1NC	6720
40	CCD.40.11.■	1NO+1NC	10650
50	CCD.50.21.■	2NO+1NC	10990
60	CCD.60.21.■	2NO+1NC	12560

'NHD' Series 2 Pole Contactor

HSN Code : 8536

2 Pole Contactors

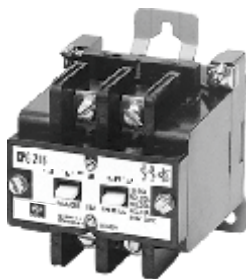

- 12, 16, 20, 25, 32 and 40 A rating
- Wide termination space

Ith (A)	AC3 (A) 240V AC	Cat. No.	MRP [₹]	Lot Size
20	12	CPG 212 ■	960	1
25	16	CPG 216 ■	1020	
40	20	CPG 220 ■	1370	
40	25	CPG 225 ■	1480	
45	32	CPG 232 ■	1695	
50	40	CPG 240 ■	1820	

For Coil Voltage Codes refer Table on page 24

'NHD' Series 4 Pole Contactor

HSN Code : 8536

4 Pole Contactors



- Superior Weld Resistant Contacts
- Rugged and heavy duty
- High Grade moulding for extremely long life
- Encapsulated Coil
 - : Shock Proof & Moisture Proof
 - : Withstand large voltage fluctuations

Size	AC1 (A)	AC3 Rating at 415 V			Cat. No.	MRP [₹]	Lot Size
		(A)	HP	KW			
CP12	20	12	7.5	5.5	CP12 ■	1760	1
00	20	16	10	7.5	C00N ■	1980	
CP20	30	20	12.5	9.3	CP20 ■	2560	
0	32	25	15	11	N0N ■	3300	
01	40	32	20	15	N01N ■	4160	
1	50	40	25	18.5	N1N ■	5065	

HSN Code : 8538

Description	Orientation	Cat. No.	MRP [₹]	Lot Size
Auxiliary Contact Blocks - NHD	1NO	001CB10	195	1
	1NO+1NC	001CB11	235	
	2NO	001CB20		
	2NC	001CB02		

■ Standard coil voltages are 24, 110, 220/240 & 380/415 VAC, 50 Hz. For voltage codes refer Table on page 24



- Quick connect plugin terminals
- Specially designed low VA coil



Proven & time tested



Definite Purpose Contactors

HSN Code : 8536

1 Pole				2 Pole			
AC3 (A)	Type	Cat. No.	MRP [₹]	AC3 (A)	Type	Cat. No.	MRP [₹]
25	1 Pole	CPD251CK	680	20	2P, 140-200VAC	CPD202BL	750
25	1 Pole with Neutral	CPD251NCK	700	25	2P, 220-240VAC	CPD252H	790
40	1 Pole	CPD401CK	740	25	2P, 415VAC	CPD252M	830
40	1 Pole with Neutral	CPD401NCK	800	40	2P, 220-240VAC	CPD402H	
				40	2P, 415VAC	CPD402M	

*wide band AC coil voltages for Defintie purpose Contactor				
Contactor	Cat No.	Voltage		
		170-240VAC	290-415VAC	140V-200VAC
25A 1P	CPD251*	KL	ML	BL
20A 2P	CPD202*			

Citation Series 3 Pole AC Control

HSN Code : 8536

Size	AC3 Rating at 415 V			Cat. No. (with Aux. contact 2NO+2NC)	MRP [₹]	Cat. No. (with Aux. contact 1NO+1NC)	MRP [₹]	Cat. No. (without Aux. contact)	MRP [₹]
	Amps	HP	KW						
C4	32	20	15	C4NE22 ■	4535	C4NE11 ■	4240	C4NE00 ■	3760
D	40	30	22	MC10DN22 ■	7175	MC10DN11 ■	6315	MC10DN00 ■	6270
E	70	50	37	MC10EN22 ■	12865	MC10EN11 ■	12600	MC10EN00 ■	12365

▪ Standard coil voltages are 24, 110, 220, 240 & 415 V AC, 50 Hz. For voltage codes refer Table on page 24

HSN Code : 8536

Size	AC1 Rating	AC3 Rating 415 V			Aux. Contact	Cat. No.	MRP [₹]	Lot Size
		A	HP	KW				
L	140	80	53	40	1NO+1NC	MCE15LN3 ■ 5	10800	1
M	150	95	62	47	1NO+1NC	MCE15M0N3 ■ 5	12950	
M-5	150	110	80	60	1NO+1NC	MCE15MN3 ■ 5	15850	
N	300	140	100	75	1NO+1NC	MCE15NN3 ■ 7	21100	1
Q	300	185	120	90	1NO+1NC	MCE15QN3 ■ 7	26300	

▪ For Coil Voltage Codes refer Table on page 24

Other Freedom Series Contactors

Duros Freedom Series 3 Pole AC Control

Size	Ac1 Rating	AC3 Rating 415 V			Aux. Contact	Cat. No.	MRP [₹]	Lot Size
		A	HP	KW				
D	32	16	10	7.5	1NO+1NC	CE15DN3 ■ B-N	1315	1
					-	CE15DN3 ■ -N	1085	
	32	18	10	7.5	1NO+1NC	CE15D1N3 ■ B-N	1325	
					-	CE15D1N3 ■ -N	1095	
E	40	25	15	11	1NO+1NC	CE15EN3 ■ B-N	1790	
					-	CE15EN3 ■ -N	1530	
F	40	32	20	15	1NO+1NC	CE15FN3 ■ B-N	3440	
					-	CE15FN3 ■ -N	3130	

Accessories - Contactors BCH

Duros-Freedom Series contactors Add-on accessories for sizes A to K, CR, BCH15KT to BCH15PT, R, S0 & S

HSN Code : 8538



Accessories	Configuration	Cat No.	Contactor Type	MRP [₹]
Aux. Contact Block (side Mounting)	1NO	C320KGSR10	CE15 & CR	150
	1NO+1NC	C320KGSR11		400
	1NC	C320KGSR01		150
	2NO	C320KGSR20		400
	1NO+1NC	BCH15S11	BCH15	470
	1NO+1NC	MC320KB11	MCE15R, MCE15S0 & MCE15S	560
	1NO+1NC (Late break type)	MC320KAS11		
	2NO+2NC	EF22	BCH54 to BCH64	5380
	1NO+1NC	EB11	BCH76 to BCH78	8355
4th Neutral Switching Pole	800A	NP800/5	BCH54 to 57	24205
	1000A	NP1000/6	BCH62 to 64	28770
	1000A	NP1000/7	BCH76 to 78	32760
Aux. Contact Block (Front Mounting)	1NO	C320KGTC10	CE15, CR	150
	1NC	C320KGTC01		
	2NO	C320KGT*20		
	2NC	C320KGT*02		
	1NO+1NC	C320KGT*11	420	
	2NO+2NC	C320KGT*22		
	3NO+1NC	C320KGT*31		
	4NO	C320KGT*40		
	1NO+3NC	C320KGT*13	BCH15	
	4NC	C320KGT*04		
	4NO	BCH15T40		
	3NO+1NC	BCH15T31		
	2NO+2NC	BCH15T22		
	1NO+1NC	BCH15T11		
	1NO	BCH15T10		
1NC	BCH15T01	260		
Pneumatic Timer Block "ON/OFF" Delay site selectable	1NO+1NC (0.1 to 30 sec)	C320TP1	CE15 & CR	1165
	1NO+1NC (0.1 to 180 sec)	C320TP2		
Mechanical Interlocks	-	C321KM60	CE15 & CR	370
	-	MC321KM3	MCE15R to MCE15S	1165
	Horizontal	BM5H	BCH54 to 57	6775
		BM6H	BCH62 to 64	11855
		BM7H	BCH76 to 78	31425
	Vertical	BM5V	BCH54 to 57	6775
		BM6V	BCH62 to 64	11855
		BM7V	BCH76 to 78	27880
	Horizontal	BM0H	BCH15KT/LT/MT	370
		BM3H	BCH15NT/PT	400

*Add suffix C for power contactors, R for control relays. The suffix C/R denote terminal marking as per standard EN5001 on BS5583 on add on aux. contact blocks used with contactors / control relays

Accessories - Contactors BCH

Add-on accessories for sizes A to K, CR, BCH15KT to BCH15PT, R, S0 & S HSN Code : 8538

Accessories	Configuration	Cat No.	Contactors Type	MRP [₹]
 Coil Surge Suppressors	24-48V (50/60Hz)	MC320LR11	CE15, CR	370
	110-240V (50/60Hz)	MC320LR12		
 Mechanical latch #	§ to complete the cat no. suffix code given	AM5- §	BCH54 to BCH57	17255
		Am6 §	BCH62 to BCH64	24405
Terminal adapter kit	3 links with m10 nut & bolt	SP37TA	MCE15R, MCE15S0 &	880

Mechanical latch are supplied with AC coils only

§ Coil Voltage suffix code for Mechanical latch AM5 & AM6

Coil voltage	110-120	220-240	380-415	440-480
Suffix Code	AW4	BA4	LB4	CB4

Accessories for Citation contactors size - L, M, M-5, N, Q, C4, D & E type HSN Code : 8538

Accessories	Configuration	Cat No.	Contactors Type	MRP [₹]
Aux. block side mounting	1NO+1NC	C320KGM11	L, M & M-5	535
	1NO+1NC	MC320KB11	N & Q	560
Aux. block add-on (Late break type)	1NO+1NC	MC320KAS11	L, M, M-5, N & Q	
	1NO+1NC	AC34EA11	C4, D & E	440
Mechanical Interlock		MC321KM1	C4 & D	475
		MC321KM2	L, M, M-5 & E	520
		MC321KM3	N & Q	1165
Terminal adapter kit	3 links with m10 nut & bolt	SP37TA	N & Q	880
Base block	1NO+1NC	MC320KB2	C4 & D	400
	1NO+1NC	AC35EB11	E	480

Spare Contacts set for Duro Freedom Contactors HSN Code : 8538

Size	Consisting of	Cat. No.	MRP [₹]
A	Complete top housing Consisting of fixed & moving contacts	SBANS3 SBANC3 SBAN4	725
B		SBBNS3 SBBNC3 SBBN4	770
C		SBCNS3 SBCNC3 SBCN4	840
D		SBDN3	1020
E		SBEN3	1200
F		SBFN3	2365
G	6 Fixed contacts 3 Moving Contacts	6-65-4	2070
H	3 springs	6-65-6	2570
J	6 Arc Bonnets	6-65-15	3490
K	3 Spring Retainer	6-65-17	3605
BCH15KT	Complete set of 6 fixed & 3 moving contacts with hardware, contact springs, spring retainers and arc runners	CP-BCH15KT-3	3570
BCH15LT		CP-BCH15LT-3	4105
BCH15MT		CP-BCH15MT-3	4420
BCH15NT		CP-BCH15NT-3	7300
BCH15PT		CP-BCH15PT-3	7300
R	6 Fixed contacts 3 Moving contacts 12 CSK screws & washers	6-288	12720
S0	3 Springs Spring retainers	6-286-S0	17175
S	Self tapping screws & washers 6 Arc Chute assly & screws	6-286	17335
BCH54	Complete set of 6 fixed & 3 moving contacts with hardware, contact springs, spring retainers and arc runners	CP-BCH54-3	19840
BCH55		CP-BCH55-3	22865
BCH57		CP-BCH57-3	32230
BCH62		CP-BCH62-3	58890
BCH64		CP-BCH64-3	72400
BCH76		CP-BCH76-3	180855
BCH78		CP-BCH78-3	203225

Spare Contacts set for NHD & Citation Contactors HSN Code : 8538

Size	Consisting of	Cat.No.	MRP [₹]
C00N N0N N01N N1N	(4 - Pole contact kit) 8 Fixed main contacts 4 Moving main contacts 4 Spring & 4 retainers	SP90A1 SP90B1 SP90D1 SP90C1	940 1960 2330 2525
C00N N0N N01N N1N	(1 - Pole contact kit) 2 Fixed main contacts 1 Moving main contacts 1 Spring & 1 retainers	SP90A01 SP90B01 SP90D01 SP90C01	230 485 565 595
CPG216 CPG225 CPG240	4 Fixed contacts 2 Main contacts 2 Spring retainers	CPG162PSP CPG252PSP CPG402PSP	460 1165 1285
C4	6 Fixed main contacts 6 Pan head screws 6 Helical lock washers	SP34K	1985
MC10D	6 Fixed Main Contacts 3 Compression springs 3 Retainers	6-334	2745
MC10E	Same as above plus 6 Blow outs 6 M5/M4 self tapping screws	6-335	5185
L	6 Fixed Contacts 6 Pan Head Screws	6-385-L0	3985
M	6 Helical Lock Washers	6-385-M	4220
M-5	3 Moving contacts 3 Springs, 3 Retainers 6 Blowouts 6 self tapping screws	6-385	4455
N	6 Fixed contacts 12 CSK screws & washers	6-293	8780
Q	3 Moving contacts 3 Springs, Spring Retainers, Self tapping screws & Washers	6-288-Q	12645

Spare ARC chambers - BCH15KT to BHC15PT, BCH54 to BCH78 HSN Code : 8538

Contactors	Cat. No.	MRP [₹]
BCH15KT	PF-BCH15KT	515
BCH15LT	PF-BCH15LT	
BCH15MT	PF-BCH15MT	
BCH15NT	PF-BCH15NT	905
BCH15PT	PF-BCH15PT	
BCH54/BCH55/BCH57 (for all 3 poles)	PF-BCH5	6800
BCH62/BCH64 (for all 3 poles)	PF-BCH6	17460
BCH76/78 (for single pole)	3PF-BCH78	37620

Contactors BCH

Spare Coil - size CR, A to K, MCE15R, MCE15S0, MCE15S, BCH15KT to BCHPT, BCH54 to BCH78

HSN Code : 8538

Size	For Size	Cat. No.	MRP [₹]
Magnetic coil	CR, A,B, C	MC15CW ■	400
	D, E, F	MC15FW ■	460
	G, H, J, K	MC15KW ■	1195
	BCH15KT/LT	B02. ■	1215
	BCH15MT	B022. ■	1810
	BCH15NT/PT/MN/NN/PN	B031. ■	3625
	R, S0, S	9-2412- ■	3255
Magnetic coil (set of two)	BCH54/ BCH55/ BCH57	B51. ■	6760
Feeder group		FG51. ■	8215
Magnetic coil (set of two)	BCH62/ BCH64	B61. ■	20755
Feeder group		FG61. ■	27165
Magnetic coil (set of two)	BCH76/ BCH78	B8- ■	57500
Feeder group		FG78- ■	63570
■ To specify coil voltage please refer page no. 24			
Note : Coil set for BCH54 to BCH78 contactors consists of 2 half coils. Magnetic coil & Feeder group must have the same control voltage. For eg. If coil voltage is changed from 110V to 220V then Feeder group should also be changed to 220V			

Spare Coil - NHD & Citation Contactors

HSN Code : 8538

Description	Cat. No.	MRP [₹]	Lot size
Carrier for NHD	SP90CC	170	1
Carrier for CPG	CPG2PCC	105	1
Magnetic coil for NHD	SP90MC*	325	10
Magnetic coil for MCE15L, MCE15M0, MCE15M	9-2268- ■	1475	1
Magnetic coil for MCE15N & MCE15Q	9-2412- ■	3255	1
Magnetic coil for C4 & MC10D	9-2267- ■	920	1
Magnetic coil for MC10E type	9-2268- ■	1475	1
■ To specify coil voltage please refer page no. 24			

Coil Voltage Table BCH

COIL VOLTAGE: MASTER TABLE

PRODUCT	24V		48V		55V	110V		160-220V	220V		220-240V	230-360V	240V	250V	275V	190-400V	260-400V	380V	380-415V	415V	440V	550V	
	AC	DC	AC	DC	DC	AC	DC	-	AC	DC	AC	-	AC	DC	AC	AC	AC	AC	AC	AC	AC	AC	DC
CR RELAY	U	U3	W	W3	-	A	A3	-	B	B3	-	-	K	-	-	-	-	L	-	M	C	D	-
#CE15A-F	U	U3	W	W3	-	A	A3	-	B	B3	-	-	K	-	-	-	-	L	-	M	C	D	-
#CE15G-K	U	U3	W	W3	-	A	A3	-	B	B3	-	-	K	-	-	-	-	L	-	M	C	D	-
BCH15KT-LT	U	-	W	-	-	A	-	-	B	-	-	-	K	-	-	-	-	L	-	M	C	D	-
BCH15MT-PT	24	-	48	-	-	110	-	-	-	-	220	-	-	-	-	-	-	-	380	-	440	550	-
BCH15MN+PN	24	-	48	-	-	110	-	-	-	-	220	-	-	-	-	-	-	-	380	-	440	550	-
MCE15R-S	U	U3	-	-	-	A	A3	-	B	-	-	-	K	-	-	-	-	L	-	M	C	D	-
BCH54-64	-	-	-	-	-	110	110	-	220	220	220	-	220	-	-	-	-	380	380	380	440	-	-
BCH76&78	-	-	-	-	-	A7	A17	-	B7	-	H	-	-	-	-	-	-	-	-	-	-	-	-
CPG216	U	-	-	-	-	A	-	BW	-	-	H	-	-	-	-	-	-	-	N	-	-	-	-
CPG225&240	U	-	-	-	-	A	-	BW	-	-	H	-	-	-	-	-	-	-	N	-	-	-	-
SHAKTI	-	-	-	-	-	-	-	-	-	-	-	-	-	-	-	Z	G	-	N	-	-	-	-
C00N & N0N	U	-	-	-	-	A	-	BW	-	-	H	-	-	-	-	-	G	-	N	-	C	D	-
N01N & N1N	U	-	-	-	-	A	-	-	-	-	H	LV	-	-	-	-	-	-	N	-	C	-	-
C4 & D	-	-	-	-	-	A	-	-	B	-	-	-	K	-	-	-	-	L	-	M	C	D	-
MC10EN	U	-	-	-	-	A	-	-	B	-	-	-	K	-	-	-	-	L	-	M	C	D	-
MCE15L-M5	U	-	W	-	-	A	-	-	B	-	-	-	K	-	-	-	-	L	-	M	C	D	-
MCE15N-Q	U	U3	-	-	-	A	A3	-	B	-	-	-	K	-	-	-	-	L	-	M	C	D	-
912X	-	U1	-	-	Q1	A1R	A1	-	-	B1	-	-	K1R	F1	-	-	-	-	-	-	-	-	D1
914;934X	-	U1	-	W1	Q1	A1R	A1	-	-	B1	-	-	K1R	F1	J1	-	-	-	-	-	-	-	D1
935X;924;915	-	U1	-	W1	Q1	A1R	A1	-	-	B1	-	-	K1R	F1	J1	-	-	-	-	-	-	-	D1
925	-	-	-	-	-	-	A1	-	-	B1	-	-	K1R	F1	-	-	-	-	-	-	-	-	D1
916&936	-	U1	-	W1	Q1	A1R	A1	-	-	B1	-	-	K1R	F1	-	-	-	-	-	-	-	-	D1
D912-D916	-	-	-	W1	-	A1R	A1	-	-	B1	-	-	K1R	F1	-	-	-	-	-	-	-	-	-

1. For other coil voltages & wide band coil option please contact nearest sales office
 2. AC control is not available for 934, 935, 936 versions.
 3. For ordering spare coils for D912, D914, D915 and D916 Contactors, please order coils with 50% voltage rating as that of control voltage.
 Example to order coils for D914 X 22B1 (which is a 220V DC DP Contactor), please order spare coils with 110V DC rating.

#The Interchangeability between AC & DC Coil of CE15 / D15 type contactors is not possible at site. Only Company fitted DC control is available for this range.

Overload Relay BCH

Citation-M Overload Relays (Direct Mounting) with built-in single phase protection

Citation Overload Relay



- Wide range : From 0.195 A to 600 A
- Built in Single Phasing Protection
- Ambient temperature compensated
- Test button for checking tripping mechanism
- Field convertible auto/manual reset
- Snap on cover
- Special Mechanism ensuring closest protection to motor
- Contact mounting & separate mounting
- Successfully tested for Type-2 Coordination
- Suitable for almost all makes of Contactors
- Proven and tested

HSN Code : 8536

HSN Code : 8538

Relay Range	Cat. No.	MRP [₹]	Terminal Block for individual mounting	MRP [₹]
0.195 - 0.31	MC305ANA3A	1330	(Incoming) MC305TB1 (Outgoing) MC305TB3	110
0.30 - 0.48	MC305ANA3B			
0.47 - 0.75	MC305ANA3C			
0.72 - 1.14	MC305ANA3D			
1.07 - 1.70	MC305ANA3E			
1.58 - 2.50	MC305ANA3F			
2.40 - 3.80	MC305ANA3G			
3.80 - 6.00	MC305ANA3H			
6.00 - 9.30	MC305ANA3J			
8.90 - 13.50	MC305ANA3K			
13.20 - 20.00	MC305ANA3L	1460	(Incoming) MC305TB2 (Outgoing) MC305TB3	
17.40 - 24.00	MC305ANA3M	1535		
22.00 - 30.00	MC305ANA3N*	2095		
23.00 - 32.00	MC305ANA3P*	2110	(Incoming) MC305TB2 (Outgoing) MC305TB3	

* Overload relay type "N & P" must be used with terminal block MC305TB3

DIN rail mounting kit with incoming terminal block HSN Code : 8538

Relay Range (A)	Cat. No.	MRP [₹]
A to K	MC305DM1	190
L to N	MC305DM2	190

CT Operated Overload Relay

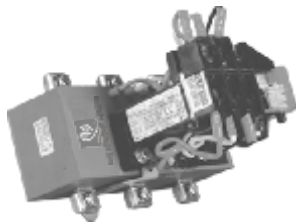

CT Operated Overload Relays-Individual Mounting HSN Code : 8536

Relay Range (A)	Cat. No.	MRP [₹]
24.4-39.0	CT1MC305ANA3C	2430
37.6-60.0	CT2MC305ANA3C	3300
56.4-90.0	CT3MC305ANA3C	4350
84.6-135.0	CT4MC305ANA3C	4750
131.6-210.0	CT5MC305ANA3C	7200
188.0-300.0	CT6MC305ANA3C	8600
263.2-420.0	CT7MC305ANA3C	8900
376.0-600.0	CT8MC305ANA3C	9900

WP 2 Pole Overload Relay

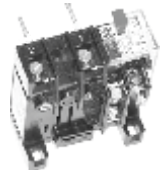

- Perfect protection to single phase Motors against overloads
- Ambient temperature compensated

2 Pole Overload Relays (Direct Mounting) HSN Code : 8536

Relay Range (A)	Cat. No.	MRP [₹]
1.58-2.50	MC307ANA2F	620
2.40-3.80	MC307ANA2G	
3.80-6.00	MC307ANA2H	
6.00-9.30	MC307ANA2J	
8.90-13.50	MC307ANA2K	
13.20-20.00	MC307ANA2L	715
17.40-24.00	MC307ANA2M	750
22.00-30.00	MC307ANA2N	900
23.00-32.00	MC307ANA2P	910

WP Overload Relay



- Designed to withstand wide fluctuations in agricultural applications
- Appropriately sensitive relay for increased pump performance

WP Overload Relays for WP & Oil Starter HSN Code : 8536

Relay Range (A)	Cat. No. (WP Starter / Oil Starter)	MRP [₹]
6.00 - 9.30	MC307ANA3J / MC307ANA3J-OS	1135
8.90 - 13.50	MC307ANA3K / MC307ANA3K-OS	
13.20 - 20.00	MC307ANA3L / MC307ANA3L-OS	1260
17.40 - 24.00	MC307ANA3M / MC307ANA3M-OS	1325
22.00 - 30.00	MC307ANA3N	1680
23.00 - 32.00	MC307ANA3P (Spare for Oil Starter)	1730

Overload Relay BCH

Duros Freedom Overload Relay



MC318ANA

- Range : From 0.1A to 80A
- IEC:60947-4-1
- Relay class-10A
- Built in Single Phasing Protection
- Ambient temperature compensated
- Test button for checking tripping mechanism
- Field convertible auto manual reset
- Contactor mounting / Individual Mounting

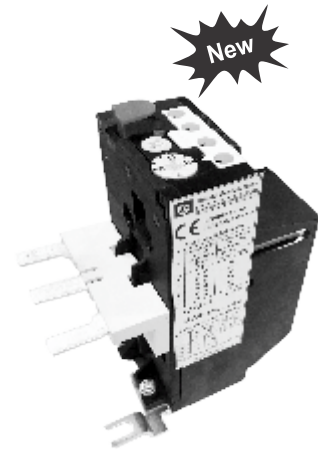

MC318GNA

Freedom Overload Relays

HSN Code : 8536

HSN Code : 8538

Relay Range (A)	Cat. No.	MRP [₹]	Accessories
0.1-0.16	MC318ANA3A	1310	Adaptor for Individual mounting Cat. No. C318F1 MRP Rs. 280
0.16-0.25	MC318ANA3B		
0.25-0.40	MC318ANA3C		
0.40-0.63	MC318ANA3D		
0.63-1.00	MC318ANA3E		
1.0-1.40	MC318ANA3F		
1.3-1.80	MC318ANA3G		
1.7-2.4	MC318ANA3H		
2.2-3.1	MC318ANA3J		
2.8-4.0	MC318ANA3K		
3.5-5.0	MC318ANA3L		
4.5-6.5	MC318ANA3M		
6.0-8.5	MC318ANA3N		
7.5-11	MC318ANA3P		
10.0-14.0	MC318ANA3Q		
13.0-19.0	MC318ANA3R	1450	Adaptor for Individual mounting Cat No. C318F2 MRP Rs.280
18.0-25.0	MC318ANA3S		
24.0-32.0	MC318ANA3T	2010	
22.0-32.0	MC318GNA3B	2185	
29.0-42.0	MC318GNA3C	2185	
36.0-52.0	MC318GNA3D	2950	
45.0-63.0	MC318GNA3E	3290	
60.0-80.0	MC318GNA3F	4050	

Vacuum Contactors..... BCH

Range: 225A to 600A 3P 1500V

Features

- Suitable for worldwide applications and for use with all types of motors including high efficiency IEC motors & NEMA design E motors.
- Front accessible
- Compact & rugged design
- Light weight
- Fully phase insulated
- Long Electrical & Mechanical life
- Mounts in any plane
- Quiet in operation



1140V 300A



1500V 400A



1500V 600A

HSN Code : 8536

Contactor Rating	Cat reference	Description	MRP [₹]
225A	CV77U033A12 -22 -B22	225A Vacu cont 1140V 3P 2NO+2NC 220VAC	95730
	CV77U033A12 -11 -B22	225A Vacu cont 1140V 3P 2NO+2NC 110VAC	
265A	CV77U033A12 -22 -B26	265A Vacu cont 1140V 3P 2NO+2NC 220VAC	106770
	CV77U033A12 -11 -B26	265A Vacu cont 1140V 3P 2NO+2NC 110VAC	
300A	CV77U033A12 -22 -B30	300A Vacu cont 1140V 3P 2NO+2NC 220VAC	117085
	CV77U033A12 -11 -B30	300A Vacu cont 1140V 3P 2NO+2NC 110VAC	
400A	CV77U034A06 -26	400A Vacu cont 1000V 3P 1NO+1NC 220VAC	148440
	CV77U034A06 -76	400A Vacu cont 1000V 3P 1NO+1NC 110VAC	
	CV77U034A06 -125	400A Vacu cont 1000V 3P 1NO+1NC 125VDC	
	CV77U034A06 -250	400A Vacu cont 1000V 3P 1NO+1NC 250VDC	
	CV77U034A15 -26	400A Vacu cont 1500V 3P 1NO+1NC 220VAC	
	CV77U034A15 -76	400A Vacu cont 1500V 3P 1NO+1NC 110VAC	
	CV77U034A15 -125	400A Vacu cont 1500V 3P 1NO+1NC 125VDC	
	CV77U034A15 -250	400A Vacu cont 1500V 3P 1NO+1NC 250VDC	
600A	CV77U036A06 -26	600A Vacu cont 1000V 3P 1NO+1NC 220VAC	194270
	CV77U036A06 -76	600A Vacu cont 1000V 3P 1NO+1NC 110VAC	
	CV77U036A06 -125	600A Vacu cont 1000V 3P 1NO+1NC 125VDC	
	CV77U036A06 -250	600A Vacu cont 1000V 3P 1NO+1NC 250VDC	
	CV77U036A15 -26	600A Vacu cont 1500V 3P 1NO+1NC 220VAC	
	CV77U036A15 -76	600A Vacu cont 1500V 3P 1NO+1NC 110VAC	
	CV77U036A15 -125	600A Vacu cont 1500V 3P 1NO+1NC 125VDC	
	CV77U036A15 -250	600A Vacu cont 1500V 3P 1NO+1NC 250VDC	

Accessories for 400A & 600A Vacuum Contactor

HSN Code : 8536

Cat reference	Description	MRP [₹]
CV77-AK1	2NO+2NC, Aux. Contact for 400A & 600A VC	10700

Electronic Overcurrent Relay BCH

Bhartia Electronic Overcurrent Relay

HSN Code : 8536

BOCR SS



- Over Current
- Locked Rotor
- Phase Loss

BOCR SSD



- Over Current
- Locked Rotor
- Phase Loss

BOCR DS3/DS1



- Over Current
- Phase Loss
- Locked Rotor
- Phase Reversal

BOCR 3DE



- Over Current
- Under Current
- Phase Loss
- Phase imbalance
- Phase Reversal
- Locked Rotor

BOCR 3EZ



- Over Current
- Under Current
- Phase Loss
- Phase Unbalance
- Phase Reversal
- Locked Rotor
- Ground Fault

BOCR PMZ

BOCR PFZ



- Over Current
- Under Current
- Phase Loss
- Phase Unbalance
- Phase Reversal
- Locked Rotor
- Ground Fault
- 4-20mA analog output

BOCR IFDM/IFDZ



- Over Current
- Under Current
- Phase Loss
- Phase Unbalance
- Phase Reversal
- Locked Rotor
- Ground Fault (in IFDZ model)
- RS-485 communication

Model	Current Range	Cat. No.	Type	MRP [₹]
BOCR SS 05	0.5-6A	MP21SS005	Analog model	3245
BOCR SS 30	3.0 -30A	MP21SS030		
BOCR SS 60	5.0-60A	MP21SS060		
BOCR SSD 05	0.5-6A	MP22SSD005	Digital model/ Inbuilt display	6070
BOCR SSD 30	3.0 -30A	MP22SSD030		
BOCR SSD 60	10-60A	MP22SSD060		
BOCR DS3 05	0.5-6A	MP34DS3005	Analog model (Definite time)	5165
BOCR DS3 30	3.0 -30A	MP34DS3030		
BOCR DS3 60	5.0-60A	MP34DS3060		
BOCR DS1 05	0.5-6A	MP32DS1005	Analog model (Inverse time)	5165
BOCR DS1 30	3.0 -30A	MP32DS1030		
BOCR 3DE	0.5-60A	MP353DE800	Inbuilt display	17120
BOCR FDE#	0.5-60A	MP35FDE800	Flush mounted display	
BOCR 3EZ	0.5-60A	MP363EZ800	Inbuilt display	18485
BOCR FEZ#	0.5-60A	MP36FEZ800	Flush mounted display	
BOCR PMZ	0.5-60A	MP37PFZ060	4-20mA analog output/ Inbuilt display	41500
BOCR PFZ#	0.5-60A	MP37PMZ060	4-20mA analog output/ Flush mounted display	42050
BOCR IFDM#	0.5-60A	MP39-IFDM400H	RS-485 comm./ Flush mounted display	22400
BOCR IFDZ#	0.5-60A	MP39-IFMZ400H	RS-485 comm./Earth fault/ Flush mounted display	28400

Note: Use suitable CT for currents above 60A

■ Control Voltage suffix for BOCR

Model no.	Control voltage					
	24-240 VAC/DC	380-440 VAC	100-240 VAC	24 VDC	100-240 VAC/DC	85-250 VAC/DC
BOCR-SS	S4	W1	-	-	-	-
BOCR-SSD	S4	W4	-	-	-	-
BOCR-DS3	S4	-	-	-	-	-
BOCR-DS1	S5	-	-	-	-	-
BOCR-3DE/FDE	-	-	Z4	U1	-	-
BOCR-3EZ/FEZ	-	-	Z4	C4	-	-
BOCR-PMZ/PFZ	-	-	-	-	-	Z7
BOCR-IFDM/IFDZ	-	-	-	-	U4	-

CTs

HSN Code : 8536

Cat No.	Description	MRP [₹]
2CT-D1-100-C	2CT EP 100/5	2425
2CT-D2-200-C	2CT EP 200/5	
2CT-D3-300-C	2CT EP 300/5	
2CT-D4-400-C	2CT EP 400/5	2885
3CT-H1-100-C	3CT version 100/5	3420
3CT-HH-150-C	3CT version 150/5	3455
3CT-H2-200-C	3CT version 200/5	3640
3CT-H3-300-C	3CT version 300/5	3870
3CT-H4-400-C	3CT version 400/5	4105
ZCT-035	ZCT version 35mm hole	3360
ZCT-080	ZCT version 80mm hole	4465
ZCT-120	ZCT version 120mm hole	9120

ZCT must be used for ground Fault protection alongwith BOCR

Cable for separate display Models

HSN Code : 8536

Cat No.	For model	Range	MRP [₹]
CABLE-RJ45-003	BOCR-IFDM/IFDZ	CABLE-RJ45 3m EOOCR-IFD model	1365
CABLE-15-003Q	BOCR-FDE/FEZ/PFZ	CABLE-15-EP 3M FEZ/FDE/PFZ	1210

Note : Cable must be ordered separately along with the EOOCR

MPCB

BCH

HSN Code : 8536

MPH range (0.1 to 32A)

NEW

- ON/OFF Rotary knob with manual operation
- Clear trip indication with rotary knob
- 1 NO + 1 NC - Front & side mounted
- Trip indicator for visual discrimination between short circuit & over load tripping
- Undervoltage / Shunt Release
- Mag only version also available

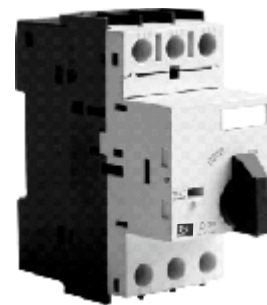
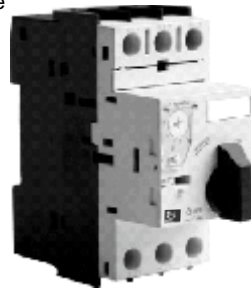

Accessories MPH range MPCB



Front mounted aux contact



Side mounted aux contact



Trip indicator - side mounted



UV/Shunt - side mounted



Extended handle - 32A MPCB

Plastic enclosure - 32A MPCB



Cat code	Description	MRP[₹]
(A) Thermal-Magnetic release		
MPH32-0.16	MPCB 3P TM 0.1- 0.16A	2755
MPH32-0.25	MPCB 3P TM 0.16-0.25A	2805
MPH32-0.4	MPCB 3P TM 0.25-0.4A	
MPH32-0.63	MPCB 3P TM 0.4-0.63A	2900
MPH32-1.0	MPCB 3P TM 0.63-1.0A	3075
MPH32-1.6	MPCB 3P TM 1.0-1.6A	3075
MPH32-2.5	MPCB 3P TM 1.6-2.5A	
MPH32-4.0	MPCB 3P TM 2.5-4.0A	3130
MPH32-6.3	MPCB 3P TM 4.0-6.3A	3200
MPH32-10	MPCB 3P TM 6.3-10.0A	3250
MPH32-16	MPCB 3P TM 10.0-16.0A	3600
MPH32-20	MPCB 3P TM 16.0-20.0A	4290
MPH32-25	MPCB 3P TM 20.0-25.0A	4610
MPH32-32	MPCB 3P TM 25.0-32.0A	7240
(B) With magnetic trip only (no Thermal release)		
MPH32M-0.16	MPCB 3P Mag only 0.16 A	2680
MPH32M-0.25	MPCB 3P Mag only 0.25 A	2725
MPH32M-0.4	MPCB 3P Mag only 0.4 A	
MPH32M-0.63	MPCB 3P Mag only 0.63 A	2825
MPH32M-1.0	MPCB 3P Mag only 1.0 A	2775
MPH32M-1.6	MPCB 3P Mag only 1.6 A	
MPH32M-2.5	MPCB 3P Mag only 2.5 A	
MPH32M-4.0	MPCB 3P Mag only 4.0 A	2945
MPH32M-6.3	MPCB 3P Mag only 6.3 A	3005
MPH32M-10	MPCB 3P Mag only 10 A	2980
MPH32M-16	MPCB 3P Mag only 16 A	3250
MPH32M-20	MPCB 3P Mag only 20 A	3480
MPH32M-25	MPCB 3P Mag only 25 A	3455
MPH32M-32	MPCB 3P Mag only 32 A	6060

HSN Code : 8538

Cat code	Description	MRP[₹]
MPHF11	Front aux contact 1NO+1 NC MPCB	515
MPHS11	Side aux contact 1NO+1 NC MPCB	675
MPHT11	MPCB Trip Indicator	795
MPH024UR	UV Rel. 24V 50HZ MPCB	1315
MPH020UR	UV Rel. 20V 50HZ MPCB	
MPH115UR	UV Rel. 110-115V 50HZ MPCB	
MPH180UR	UV Rel. 180V 50HZ MPCB	
MPH240UR	UV Rel. 230-240V 50HZ MPCB	
MPH380UR	UV Rel. 380V 50HZ MPCB	
MPH415UR	UV Rel. 400-415V 50HZ MPCB	
MPH500UR	UV Rel. 500V 50HZ MPCB	
MPH024SR	Shunt Rel. 20-24V 50/60HZ MPCB	
MPH048SR	Shunt Rel. 40-48V 50/60HZ MPCB	
MPH240SR	Shunt Rel. 200-240V 50/60HZ MPCB	1080
MPH440SR	Shunt Rel. 365-440V 50/60HZ MPCB	
MPH127SR	Shunt Rel. 100-127V 50/60HZ MPCB	
MPH34	Extnd rotary handle 32A	1430
B31SMA1	Plastic enclosure for MPH32 MPCB	

MPE Range (0.1 - 25A)



- Conforms to IEC 60947
- Perfect Coordinated system for Motor Control
- Electrical Life : 100000 Operations
- Excellent Current limiting characteristics
- Modular Snap fit Accessories
- 2 Pole version, Only Magnetic Trip Version available on request

MPCB (with thermal & magnetic release) HSN Code : 8536

Cat ref	Setting Range (A)	Motor Rating in kW at 415 V	MRP [₹]
MPE-01	0.1...0.16	-	2395
MPE-02	0.16...0.25	0.06	
MPE-03	0.25...0.4	0.12	
MPE-04	0.4...0.63	0.18	2645
MPE-05	0.63...1	0.25, 0.37	
MPE-06	1...1.6	0.55	2680
MPE-07	1.6...2.5	0.75, 1.1	
MPE-08	2.5...4	1.5	2735
MPE-10	4...6.3	2.2, 3	
MPE-14	6.3...10	4, 5	2865
MPE-16	10...16	5.5, 9	3335
MPE-20	16...20	11	3560
MPE-22	20...25	12.5	3835



Accessories of MPE Range

HSN Code : 8538



Reference	Contacts	MRP [₹]
Auxiliary	Switch	
MPA-0010	1NO	375
MPA-0001	1NC	
MPA-0011	1NO + 1NC	
MPA-0020	2NO	570
Enclosures (IP55)		
MPA-EF	Flush mounted	800
MPA-ES	Surface mounted	890
Voltage Releases		
MPA-U ■	Under Voltage Release	1235
MPA-S ■	Shunt Release	

■ A: 110 VAC, K: 240 VAC, M: 415 VAC, U: 24 VAC, R: 42 VAC

HSN Code : 8538

Reference	Tap-o *	MRP [₹]
Bus Bar		
MPA-BB245	2 Tap-o (45mm)	535
MPA-BB345	3 Tap-o (45mm)	585
MPA-BB445	4 Tap-o (45mm)	890
MPA-BB545	5 Tap-o (45mm)	975
MPA-BB263	2 Tap-o (63mm)	585
MPA-BB463	4 Tap-o (63mm)	880
MPA-BB1	Incoming Block	535

*centre to centre distance.

MS32 range (0.1 to 32A)

- Auxiliary switch for side mounting & flush mounting
- Indication of release with trip indicating auxiliary switch

HSN Code : 8536



Cat ref	Setting range (A)	Motor rating in KW at 415V	MRP[₹]
MS32-0.16	0.1-0.16	-	2445
MS32-0.25	0.16-0.25	0.06	
MS32-0.4	0.25-0.4	0.09	
MS32-0.63	0.4-0.63	0.12 to 0.18	2610
MS32-1.0	0.63-1.0	0.18 to 0.25	
MS32-1.6	1.0-1.6	0.37 to 0.55	2660
MS32-2.5	1.6-2.5	0.75	2800
MS32-4.0	2.5-4	1.1 to 1.5	2870
MS32-6.3	4-6.3	2.2	
MS32-10	6.3-10	3 to 4	3260
MS32-14.0	9-14	5.5	
MS32-18	13-18	7.5	3395
MS32-23	17-23	9 to 11	3705
MS32-27	20-27	11	4030
MS32-32	25-32	15	6050



Accessories - MS32 range

HSN Code : 8538

Cat ref	type	Contacts	MRP[₹]
HS11	Aux contact side mounting	1NO+1NC	580
HSV10	Aux contact top mounting	1NO	505
HSV01		1NC	
HRS10	Trip indicating block top mounting	1NO	365
HRS01		1NC	
MS32-UR	Under voltage release	-	1315
MS32-AR	Shunt release	-	

Note: For further details, please contact nearest sales office

Solid State Relays (SSR)

Single Phase SSR's for Heating Applications

SC9 Series 1-Phase ZERO CROSS Without LED HSN Code : 8536



Cat. No.	MOQ	AC51 Rating	I ² t (A ² S)	Peak Voltage	Operating Voltage	Control Voltage	MRP [₹]
SC941110L	5	12A	72	600V AC	12-280V AC	4-30V DC	1200
SC942110L	5	25A	288	600V AC	12-280V AC	4-30V DC	1405
SC944110L	5	40A	612	600V AC	12-280V AC	4-30V DC	1810

MOQ - Minimum Order Qty.

- Electronic Switching of loads - silent operation
- Life Over 100 million operations
- High Switching Frequency
- Ideal for dusty & corrosive atmosphere
- Impact & Vibration resistant
- Direct compatibility with PLC
- LED Indication as option

SC9 Series 1-Phase ZERO CROSS With LED HSN Code : 8536

Cat. No.	MOQ	AC51 Rating	I ² t (A ² S)	Peak Voltage	Operating Voltage	Control Voltage	MRP [₹]
SC941160L	5	12A	72	600V AC	12-280V AC	4-30V DC	1210
SC942160L	5	25A	288	600V AC	12-280V AC	4-30V DC	1425
SC944160L	5	40A	612	600V AC	12-280V AC	4-30V DC	1840
SC945160L	5	50A	1500	600V AC	12-280V AC	4-30V DC	3765
SC947160L	5	75A	5000	600V AC	12-280V AC	4-30V DC	4190

MOQ - Minimum Order Qty.

SC9 Series 1-Phase ZERO CROSS With LED HSN Code : 8536

Cat. No.	MOQ	AC51 Rating	I ² t(A ² S)	Peak Voltage	Operating Voltage	Control Voltage	MRP [₹]
SC962160L	5	25A	265	1200V AC	24-600V AC	5-30V DC	5075
SC965160L	5	50A	1500	1200V AC	24-600V AC	5-30V DC	6390
SC967100	2	75A	5000	1200V AC	24-600V AC	5-30V DC	9965

MOQ - Minimum Order Qty.



Innovation - Performance-Design

- Removable IP20 flaps.
- Only 29 mm height.
- Designed for all types of loads.
- TMS² Technology with very long life expectancy.
- Control Status LED.
- Very low zero cross level.
- UL/cUL, VDE (EN60950), IEC/EN60947-4-3, CE marking

SO9 Series 1-Phase ZERO CROSS With LED in okpac[®] Housing IP20 Protection HSN Code : 8536

Cat. No.	MOQ	AC51 Rating	I ² t(A ² S)	Peak Voltage	Operating Voltage	Control Voltage	MRP [₹]
SO942560*	2	25A	600	600V AC	12-280V AC	7-30V DC	3205
SO963460*	2	35A	1250	1200V AC	24-600V AC	3.5-32V DC	3835
SO945460*	2	50A	2500	600V AC	12-280V AC	3-32V DC	4060
SO965460*	2	50A	2800	1200V AC	24-600V AC	3.5-32V DC	4275
SO967460*	2	90A	7200	1200V AC	24-600V AC	3.5-32V DC	4930

*Non Sock Items, allow 4-6 weeks delivery time

MOQ - Minimum Order Qty.

Solid State Relay BCH



SU9 Series 1-Phase ZERO CROSS With LED in okpac® Housing IP20 Protection

HSN Code : 8536

Cat. No.	MOQ	AC51 Rating	Peak Voltage	Operating Voltage	Control Voltage	MRP [₹]
SU942460*	44	25A	600V AC	12-280V AC	3-32V DC	On Request
SU963460*	44	35A	1200V AC	24-600V AC	3.5-32V DC	On Request
SU965460*	44	50A	1200V AC	24-600V AC	3.5-32V DC	2160
SU967460*	44	75A	1200V AC	24-600V AC	3.5-32V DC	2270

*Non Stock items, allow 4-6 weeks delivery time.

SU Range

- Designed for resistive load
- With pluggable connector on input
- IP20 protection with Removable
- For mounting on Heat sink or panel mount
- Over voltage protection on input
- Control Status LED
- Very low zero cross level
- Quick and easy connection



Single Phase SSR's for Capacitor Control Applications SO8 Series 1-Phase With LED

in okpac® Housing IP20 Protection

HSN Code : 8536

Cat. No.	MOQ	AC51 Rating	I ² t(A ² S)	Peak Voltage	Operating Voltage	Control Voltage	MRP [₹]
SO842074*	2	25A	600	600V AC	12-275V AC	3-32V DC	3910
SO863070*	2	35A	1250	1200V AC	24-510V AC	3.5-32V DC	4320
SO845070*	2	50A	2500	600V AC	12-275V AC	3-32V DC	4625
SO848070*	2	95A	14400	600V AC	12-275V AC	3-32V DC	6965
SO889060*	2	125A	24000	1600V AC	24-600V AC	3.5-32V DC	18505

*Non Stock Items, allow 4-6 weeks delivery time

MOQ - Minimum Order Qty.

Single Phase SSR's for Motor Control Applications

SC7 Series 1-Phase Without LED (Random Switching)

HSN Code : 8536

Cat. No.	MOQ	AC51 Rating	AC53 Rating	I ² t (A ² S)	Peak Voltage	Operating Voltage	Control Voltage	MRP [₹]
SC741110L	5	12A	2.5A	72	600V AC	12-280V AC	4-30V DC	1180
SC761110L	5	12A	2.5A	72	1200V AC	24-520V AC	5-30V DC	1760
SC742110L	5	25A	5A	312	600V AC	12-280V AC	4-30V DC	1395
SC762110L	5	25A	5A	265	1200V AC	24-520V AC	5-30V DC	2495
SC744110L	5	40A	9A	612	600V AC	12-280V AC	4-30V DC	2695
SC764110L	5	50A	12A	1500	1200V AC	24-520V AC	5-30V DC	5640
SC767110L	5	75A	16A	5000	1200V AC	24-520V AC	5-30V DC	9660
SC768110L	5	95A	20A	11000	1200V AC	24-520V AC	5-30V DC	9965
SC769110L	5	125A	30A	20000	1200V AC	24-520V AC	5-30V DC	16065

MOQ - Minimum Order Qty.

Direct Copper Bonding Technology

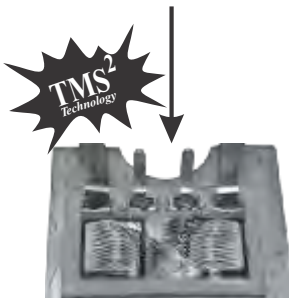

- Fewer joints, fewer layers results in better thermal characteristics
- Extremely low temperature rise ensures long life

SO7 Series 1-Phase With LED in okpac® Housing IP20 Protection (Random Switching)

HSN Code : 8536

Cat. No.	MOQ	AC51 Rating	AC53 Rating	I ² t(A ² S)	Peak Voltage	Operating Voltage	Control Voltage	MRP [₹]
SO745090	2	50A	12A	2500	600V AC	12-275V AC	3-32V DC	5435
SO767090	2	75A	16A	7200	1200V AC	24-510V AC	3.5-32V DC	7980
SO768090	2	95A	20A	14400	1200V AC	24-510V AC	3.5-32V DC	9360
SO769090	2	125A	30A	24000	1200V AC	24-510V AC	3.5-32V DC	13725

*Non Stock Items, allow 4-6 weeks delivery time

MOQ - Minimum Order Qty.

Solid State Relay BCH

Three Phase SSR's SVT Series 3-Phase With LED (ZERO CROSS) IP20 Protection

HSN Code : 8536



- IP20-RC and VDR Protection
- Designed for all types of load
- Thyristor technology

Cat. No.	MOQ	AC51 Rating	AC53 Rating	I ² t(A ² S)	Peak Voltage	Operating	Control Voltage	MRP [₹]
DC CONTROL								
SVT861394	2	12A	2.5A	72	1200V AC	24-520V AC	8.5-30V DC	17085
SVT864374	2	50A	12A	1500	1200V AC	24-520V AC	10-32V DC	20845
SVT868394E	2	95A	24A	5000	1200V AC	24-520V AC	8.5-30V DC	21865
SVT869394	2	125A	32A	20000	1200V AC	24-520V AC	8.5-30V DC	25930
AC CONTROL								
SVT864994	2	50A	12A	1500	1200V AC	24-520V AC	90-240V AC	21865
SVT967960	2	75A	-	1500	1200V AC	24-520V AC	90-240V AC	24610
SVT869994	2	125A	32A	20000	1200V AC	24-520V AC	90-240V AC	26945

MOQ - Minimum Order Qty.



Common IP20 Protective Cover for SC series SSR.



Heat Sink - 65 mm

- Wide range of Heat sinks offers perfect coordination with all SSRs

Accessories for SSR HSN Code : 8538

Cat. No.	MOQ	Description	MRP [₹]
SC1K4600	20	IP20 Cover SC*	30
SCHS6 DIN	20	Din Clip	130
SCHS2200	5	Heat Sink 2.2K/W	810
SCHS1100	5	Heat Sink 1.1 K/W	2635
SCHS0900	5	Heat Sink 0.9 K/W	3115
SCHS0300	5	Heat Sink 0.3K/W	5080

*IP20 Protective Cover for complete SC range
Refer to nearest branch office for heat sink selection

Suggested Heat Sink Rth values (K/W) for load rating at diff. Ambient Temperature

SSR Rating (A)	25°C	35°C	45°C	55°C
12A	2.2	2.2	2.2	1.1
25A	1.1	1.1	0.3	0.3
40A	0.3	0.3	0.3	0.3
50A	0.3	0.3	0.3	0.3
75A	0.3	0.3	0.3	0.3
95A	0.3	0.3	0.3	-
125A	0.3	0.3	-	-

* For Heat Sink Selection of S07 / S08 / S09 / SG4 / SG5 ranges refer to nearest sales office

Note: Apply heat sink compound between SSR base and external heat sink. In case of closely packed units the ambient temperature condition should be considered carefully. For proper protection, short-circuit protection device (SCPD) (having I²t rating lower than that of SSR I²t) must be used.

DC Contactors

BCH

DC Mill Duty Contactor HSN Code : 8536

No. of poles	(A)	Auxilliary Contacts	Cat. No.	MRP [₹]
50 Amperes				
Single pole Normally Open	15A 25A 50A	2NO+2NC 2NO+2NC 2NO+2NC	912x1522 ■ 912x2522 ■ 912x5022 ■	25050
Double pole Normally Open	15A 25A 50A	2NO+2NC 2NO+2NC 2NO+2NC	D912x1522 ■ D912x2522 ■ D912x5022 ■	53850
Mechanically Interlocked 2 Nos. SP NO	15A 25A 50A	2NO+2NC 2NO+2NC 2NO+2NC	M912x1522 ■ M912x2522 ■ M912x5022 ■	59725
150 Amperes				
Single pole Normally Open	150A	2NO+2NC	914x22 ■	42775
Double pole Normally Open	150A	2NO+2NC	D914x22 ■	91715
Mechanically Interlocked 2 Nos. SP NO	150A	2NO+2NC	M914x22 ■	96790
Single pole Normally Closed	150A	1NO+1NC	924x11 ■	44060
NEW Double Pole Normally Closed	150A	2NO+2NC	D924x22 ■	93490
Single pole Normally Open with Holdout Coil #	150A	1NO+1NC	934x11 ■	46375
Single pole Normally Open with AC Blow out Coil	150A	2NO+2NC	974x22 ■	54235
300 Amperes				
Single pole Normally Open	300A	2NO+2NC	915x22 ■	62115
Double pole Normally Open	300A	2NO+2NC	D915x22 ■	132290
Mechanically Interlocked 2 Nos. SP NO	300A	2NO+2NC	M915x22 ■	137545
Single pole Normally Closed	300A	1NO+1NC	925x11 ■	62430
NEW Double Pole Normally Closed	300A	2NO+2NC	D925x22 ■	134860
Single pole Normally Open with Holdout Coil #	300A	1NO+1NC	935x11 ■	67410
Single pole Normally Open with AC Blow out Coil	300A	2NO+2NC	975x22 ■	78545

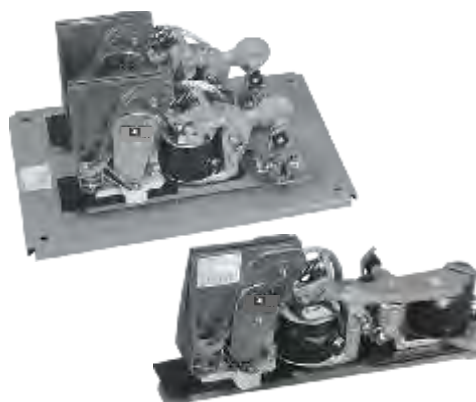

- From 50 A to 600 A
- Conforms to NEMA Standards
- Ready to use mechanically interlocked version
- Normally closed version
- Hold on coil for time delay
- Mechanical life : 20 million operation
- Electrical life : 1 million operation

Unique Arc
quenching system with
blow out coils for
switching heavy duty
loads

DC Mill Duty Contactor HSN Code : 8536

No. of poles	(A)	Auxilliary Contacts	Cat. No.	MRP [₹]
600 Amperes				
Single pole Normally Open	600A	2NO+2NC	916x22 ■	138440
Double pole Normally Open	600A	2NO+2NC	D916x22 ■	287465
Mechanically Interlocked 2 Nos. SP NO	600A	2NO+2NC	M916x22 ■	292120
Single pole Normally Closed	600A	1NO+1NC	926x11 ■	142305
Single pole Normally Open with Holdout Coil#	600A	1NO+1NC	936x11 ■	175885
Single pole Normally Open with AC Blow out Coil	600A	2NO+2NC	976x22 ■	181025

For 934 / 935 / 936 with holdout coil, suffix voltage code from table for 150, 300 & 600 Amps replace 'x' by 'y' for surface mounting rear connection, 'z' for elevated mounting rear connection

* Add Rs. 2840/- for AC Control

Double Pole DC Mill Duty Contactor HSN Code : 8536

A	Auxilliary Contacts	Cat. No.	Unit Price [₹]
150A	2NO+2NC	954x22 ■	Contact Branch office
300A	2NO+2NC	955x22 ■	for Price

DC Contactors BCH

DC Mill Duty Contactors - Spares

HSN Code : 8538

Description	Qty. Reqd.	50A		150A		300A		600A	
		Cat. No.	MRP [₹]	Cat. No.	MRP [₹]	Cat. No.	MRP [₹]	Cat. No.	MRP [₹]
DC Arc Chute Assy. Consisting of a. LH Arc Shield b. RH Arc Shield c. DC Blow Out Arc Horn d. DC Blow Out Arc Piece e. DC Blow Out Spacer Assy. f. Polarity Wire g. Latch Strips (Top & Bottom) h. Hardware for Polarity Wire & Latch	1 Set	9C9J101*	12680	9C9P101	21725	9C9T101	31500	9C9V101	68570
AC Arc Chute Assy. Consisting of a. LH Arc Shield b. RH Arc Shield c. AC Blow Out Pole Piece d. AC Blow Out Spacer Assy. e. Polarity Wire f. Latch Strips (Top & Bottom) g. Hardware for Polarity Wire & Latch	1Set	-	-	9C9P102	On request	9C9T102	On request	9C9V102	On request
Fixed & Moving Contacts	1 Set	9C9J105	2750	9C9P105	3780	9C9T105	6145	9C9V105	16725
Contact Lever with Braid (for Single Pole)	1 No.	9C9J106	3345	9C9P106	5460	9C9T106	7230	9C9V106	12545
Contact Lever with Braid (for Double Pole) [†]	1 No.	9C9J106	3345	9C9P106	5460	9C9T106	7230	9C9V103	12545
Set of Armature Spares Consisting of a. Adjusting Pin b. Contact lever spring c. Contact lever spring pin with circlip d. Armature hinge pin e. Armature Securing pin	1 Set	9C9J107	1185	9C9P107	1650	9C9T107	2380	9C9V107	3460
Set of Armature Spares for 924, 925, 926 Consisting of a. Adjusting Pin b. Contact lever spring c. Contact lever spring pin with circlip d. Armature hinge pin e. Armature Securing pin f. Armature spring g. Spring retaining washer	1 Set	-	-	9C9P108	2010	9C9T108	2990	9C9V108	4290
Set of Armature Spares for 934/935/936 Consisting of a. Adjusting pin b. Contact lever spring c. Contact lever hinge pin d. Armature hinge pin e. Armature securing pin f. Armature spring g. Spring retaining washer h. Adjusting screw	1 Set	-	-	9C9P109	2405	9C9T109	3555	9C9V109	4555
Terminal Block	1	9C9J110	1530	9C9P110	2010	9C9T110	2820	9C9V110	3520
No Volt Coil for 912, 914, 915, 916, 934, 935 & 936 **Suffix voltage code	1	9C9J111■	5690	9C9P111■	8705	9C9T111■	11455	9C9V111■	19745
No Volt Coil for 924, 925, 926 **Suffix voltage code	1	-	-	9C9P112■	11455	9C9T112■	17800	9C9V112■	28755
Coil clamp for 914 & 934	1	-	-	9C9P118	215	-	-	-	-
Coil clamp for 924, 915, 935, 916 & 936	1	-	-	9C9P118	215	9C9T118	215	9C9V118	On request

■ Suffix coil voltage code from table on page 24
■ Please add Rs. 2840 for AC control

* Only item a to e is supplied in this set
† For two Poles, need to order for 2 Nos.

DC Contactors BCH

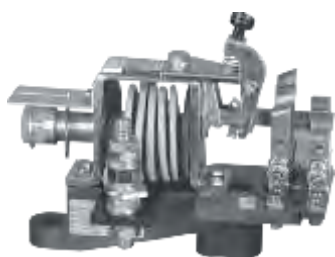

- Magnetic Operated Overload relay for heavy duty applications
- From 1.5A to 600A
- Instantaneous and Time delay tripping
- Manual and automatic resetting
- 1NO + 1NC Contacts

DC Mill Duty Contactors - Spares & Accessories HSN Code : 8538

Description	Cat. No.	MRP [₹]
1NO+1NC Auxilliary Contact Block	AC10E11	5045
2NO Auxilliary Contact Block	AC10E20	5045
2NC Auxilliary Contact Block	AC10E02	5045
Single unit driver with mounting plate (50 A)	9C9J115	790
Double unit driver with mounting plate (50 A)	9C9J116	1145
Single unit driver with mounting plate (150-600A)	9C9P116	855
Double unit driver with mounting plate (150-600A)	9C9P117	1255
Hold out coil for 934, 935 & 936	9C9P113-■	13830
Condenser 50 + 50uF for 934, 935 & 936	9C9P114	855
Mechanical interlock for 150/300/600A	AC10M4/M8/M12	5625
Rectifier 110/240 V	SP30R	2840

■ Suffix voltage code from Table on page 24

DC Magnetic Overload Relays *

HSN Code : 8536

Cat. No.	Coil No.	Continuous Rating	Range Amps	MRP [₹]
B3A23	159-10	2.8	1.5 to 3.5	14665
B3B23	159-5	3.9	3 to 7	
B3C23	159-4	5.4	5 to 13	
B3E23	159-3	10.9	8 to 24	
B3F23	159-2	16.9	10 to 30	
B3G23	159-1	21.9	20 to 40	
B3H23	159-8	34.9	25 to 65	
B3J23	159-6	50.0	35 to 75	
B3K23	179-39	69.0	40 to 120	17180
B3L23	179-38	109.0	70 to 190	
B3M23	179-37	179.0	100 to 300	
B3N23	179-36	250.0	200 to 600	18735
B3Y23	179-36.2	199.0	200 to 600	
B3P23		549.0	300 to 900	22790
B3R23		500.0	500 to 1500	

* With 1NO + 1NC Contacts

Hold Out Coil details for 934/935/936

Hold out coil code	Voltage
494-1	400/500
494-2	100/125
494-5	200/250 & 400/550
494-7	400/450
492-12	100/125
494-43	200/250 & 400/550

Heavy Duty Limit Switch - Snap Action Type NL IP 67

HSN Code : 8536

Type	Description	Cat. No. Screw Terminal (1NO+1NC)	MRP [₹]	Cat.No. Precabled (1NO+1NC)	MRP [₹]	Cat. No. Screw Terminal (2NO+2NC)	MRP [₹]	Cat. No. Precabled (2NO+2NC)	MRP [₹]
Roller Lever	Standard-38MM Standard-76.2mm Adjustable	NLL1 NLL2 NLLA	1545	NLL1C NLL2C NLLAC	1680	NLL1-22 NLL2-22 NLLA-22	2360	NLL1-22C NLL2-22C NLLA-22C	2445
	Maintained Type Maintained Type Maintained Type	NLL1M NLL2M NLLAM	1735	NLL1MC NLL2MC NLLAMC	1815	NLL1M-22 NLL2M-22 NLLAM-22	2610	NLL1M-22C NLL2M-22C NLLAM-22C	2660
Push Roller	Top Side	NLTPR	1545	NLTPRC	1680	NLTPR-22	2360	NLTPR-22C	2445
		NLSPR	1695	NLSPRC	1815	NLSPR-22	2545	NLSPR-22C	2660
Push Button	Top Adjustable Side Adjustable	NLTPBA	1545	NLTPBAC	1680	NLTPBA-22	2300	NLTPBA-22C	2445
		NLSPBA	1695	NLSPBAC	1815	NLSPBA-22	2545	NLSPBA-22C	2660
Cat Whisker	Nylon Rod Steel Rod	NLCW	1355	NLCWC	1455	NLCW-22	2245	NLCW-22C	2360
		NLJW	1545	NLJWC	1650	NLJW-22	2360	NLJW-22C	2445
Fork Type	Roller in same line Offset Rollers	NLLF NLLFO	1735	NLLFC NLLFOC	1815	NLLF-22 NLLFO-22	2615	NLLF-22C NLLFO-22C	2660
	Roller in same line Maintained Offset Rollers Maintained	NLLFM		NLLFMC		NLLFM-22		NLLFM-22C	
		NLLFOM	2030	NLLFOMC	2110	NLLFOM-22	2830	NLLFOM-22C	2885

- IP 67 degree of Protection
- Choice of 16 Operating Heads
- Interchangeable heads ensures complete modularity and flexibility
- Zinc Die cast body for Heavy duty applications
- Easily replaceable contact blocks
- Precabled version with 2m cable length

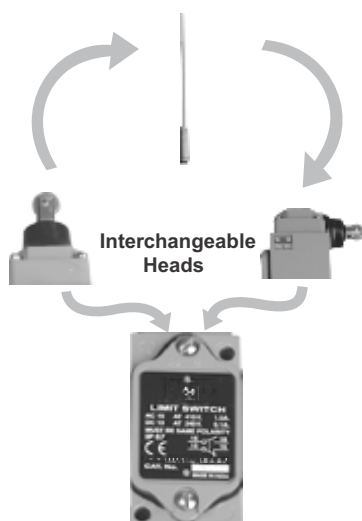



Mini Limit Switch NEW

HSN Code : 8536

Type		Cat. No.	MRP [₹]
General Purpose Type		DLSMAR	1010
Top Plunger	Standard	DLSMPP	
Push Roller	Standard	DLSMRP	
	Cross	DLSMRPX	
Roller Lever	39mm	DLSMRL	1050
	Adjustable	DLSMRLA	
Rod Arm	Adjustable	DLSMJWA	1110
Cat's Whisker	Steel Spring	DLSMSW	
Flexible Rod	Nylon	DLSMSR	

Applications

- Lifts and Escalators
- Machine Tools
- Food and Beverages
- Textile Machines
- Packaging & Printing Machines

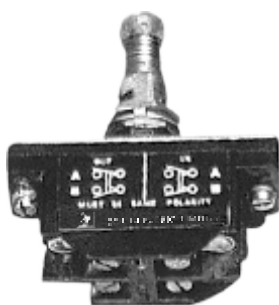
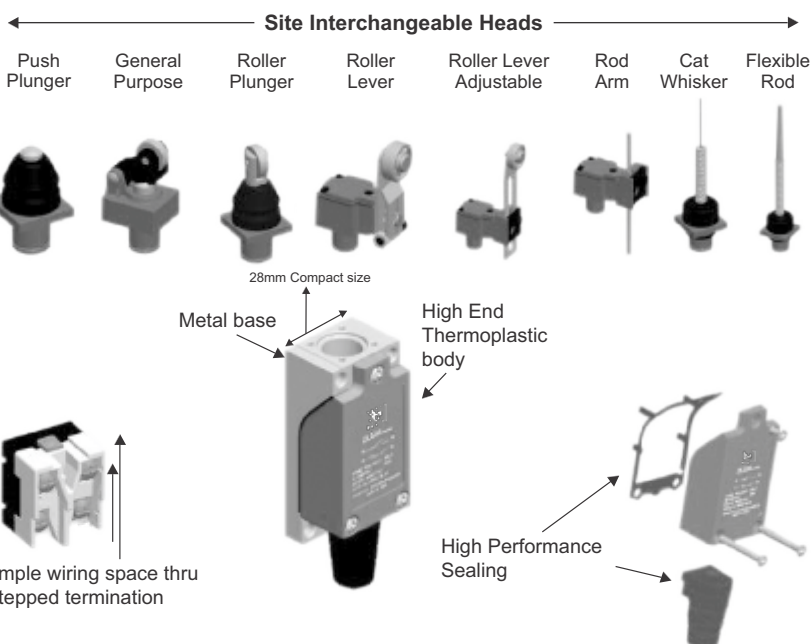

Precision Limit Switch

HSN Code : 8536

Type of Operator	1NO+1NC		2NO+2NC		Lot Size
	Cat. No.	MRP [₹]	Cat. No.	MRP [₹]	
Roller Lever	PSRL-L or R	610	PSRL-L-2 or R-2	735	1
Six Inch Lever	PSSIL-L or R		PSSIL-L-2 or R-2		
Top Push Roller	PSTPR*		PSTPR*-2		
Top Push Button	PSTPB		PSTPB-2		
Type	Cat. No	MRP [₹]	Cat. No	MRP [₹]	Lot Size
Spare Contact Block	SP20S1	575	SP20S2	720	

* A or B

- Conforming to IEC 60947-5-1
- Compact Design requiring less mounting space
- Zinc Die cast base & high end polyamide cover ensuring robustness & excellent aesthetics
- Unique Cross bar contacts for enhanced reliability
- Dust proof, Water proof & Oil resistance construction
- Snap action contacts
- Frequency of operation 7200 Oprns / hr

Limit Switches

BCH

Limit Switch for 125°C Application*

HSN Code : 8536

Type	Cat. No.	MRP [₹]
with 1NO + 1NC Roller Lever Top Push Roller	LL1-150S-M LTPR-150S-M	On Request

*Refer to our nearest sales office for specification & details

Heavy Duty General Purpose Limit Switch

HSN Code : 8536

Snap Action Type L	Angular Roller Top Plunger	LLGS LPGS	1020
-----------------------	-------------------------------	--------------	------

Oil Tight Limit Switch - Snap Action Type L IP 65

HSN Code : 8536

Type	Description	Cat. No.	MRP [₹]
Roller Lever	Standard-38MM	LL1	2195
	Standard-76.2mm	LL2	
	Adjustable	LLA	
Push Roller	Maintained Type LL1	LL1M	2290
	Maintained Type LL2	LL2M	
	Maintained Type LLA	LLAM	
Push Button	Top	LTPR	2145
	Side	LSPR	2410
Push Button	Top Adjustable	LTPBA	2325
	Side Adjustable	LSPBA	
Cat Whisker	Nylon Rod	LCW	1755
	Steel Rod	LJW	2185
Fork Type	Roller in same line	LLF	1975
	Offset Rollers	LLFO	1975
	Roller in same line	LLFM	2305
	Maintained	LLFOM	2305
	Offset Rollers		
Maintained			

Oil Tight Limit Switch - Spares

HSN Code : 8538

Description	Suitable for	Cat. No.	MRP [₹]
38 mm lever	NLL1, LL1	SP40L1	340
76.2 mm lever	NLL2, LL2	SP40L2	430
Adjustable lever	NLLA, LLA	SP40LA	430
Operating Head	LLGS, LPGS	SP40HLG	630
Operating Head	Lever	SP40HL	680
Operating Head	Top	SP 40HTP*	680
	Plunger	SP 40HSP*	760
Operating Head	Cat Whisker	SP40CW	465
	Steel Rod	SP40JW	630
Limit Switch Unit Assembly 1NO+1NC	Type 'L' & 'NL' (Except LLGS / LPGS)	SP40S1	975
Limit Switch Unit Assembly 2NO+2NC		SP40S2	1610
Limit Switch Unit Assembly 1NO+1NC	LLGS / LPGS	SP40S1WOM	630
Fork lever in Line	LLF	SP40LF	525
Fork lever Offset	LLFO	SP40LFO	525
Operating Head Maintained	Lever	SP40HLM	790
Oil tight Conduit		SP40CE	370

* B = Button R = Roller

Foot Switch & Push Button 30.5mm..... BCH

HSN Code : 8536



Number of Contact Blocks	Total contacts available	No. of position	Description	Cat. No.	MRP [₹]	Lot Size
One	1NO+1NC	2	With Guard	FSGX1	3550	1
One	1NO+1NC	2	With Latch	FSGX1L	3740	
One	2NO+2NC	2	With Guard	FSGX2	3860	
One	2NO+2NC	2	With Latch	FSGX2L	4025	
Two	2NO+2NC	2	With Guard	FSGY1	4355	
Two	2NO+2NC	2	With Latch	FSGY1L	4635	
Two	4NO+4NC	2	With Guard	FSGY2	5085	
Two	4NO+4NC	2	With Latch	FSGY2L	5180	
Two	1NO+1NC	3	With Guard	FSGZ1M	4430	
Two	4NO+4NC	3	With Latch	FSGZ2M	5070	

Note : Latching unit (with suffix L) is provided with X & Y versions only.

Spares for Foot Switch

HSN Code : 8538

Description	Suitable For	Cat No.	MRP [₹]
Spare Contact Block 1NO+1NC	FGS/FSS	SP20S1	575
Spare Contact Block 2NO+2NC	FSG/FSS	SP20S2	720
Spare Cover with Guard	FSG	SP20CG	1420

- 2 Position and 3 Position
- 1NO+1NC/2NO+2NC/4NO+4NC contact blocks
- Guard and Shielded versions
- Oil tight and water tight enclosure for contact block
- Mechanical and electrical life : 10 million operation
- Suited for heavy duty applications such as :
Machine Tools
Rubber and Tyre making machines
SPMs
Welding Machines
- Suffix X1 = One Block of 1NO+1NC
X2 = One Block of 2NO+2NC
Y1 = Two Blocks of 1NO+1NC
Y2 = Two Blocks of 2NO+2NC

Oil Tight Push Button & Indicating Lights - 'Type T' E 30.5 mm

HSN Code : 8536



Range

- Non illuminated and illuminated
- Flush
- Extended
- Mushroom head
- Lever and key type selector switch
- Indicators-Direct/Resistor/Transformer type
- Conforms to EN/IEC-60947-5/IS-13947-5

Features

- Protection degree - IP65
- Rugged construction
- Ideal for motor control centers and control panels
- Proven time tested design

Type	Description	Cat. No.	MRP [₹]	HSN Code	Lot Size	
Actuator	Standard flush Button Red Green Black Yellow Blue Amber	TSFB-R TSFB-G TSFB-B TSFB-Y TSFB-BL TSFB-A	195	8536	20	
	Long Button Red Green Black Yellow Blue Amber (Orange)	TLB-R TLB-G TLB-B TLB-Y TLB-BL TLB-A	195	8536	10	
	Mushroom Head -Spring return Red -Spring return Green -Turn to release Red -Turn to release Green	TMH-R TMH-G TMHL-R TMHL-G	255 255 280 280	8536	10	
	Selector Actuator -2 or 3 position	TSSA ***	510	8536	10	
	Cylindrical Lock -2 or 3 positions	TCL ***	745	8536	10	
	Station	Start/Stop Pushbutton	E20EA	880	8536	1
	Contact Block	1NO +1NC 2NO 2NC	050N1 050N2 050N3	250	8536	20
	Aluminium Diecast Enclosure	One button Two buttons Three buttons	TEN-1 TEN-2 TEN-3	835 975 1260	8536	1
	HSN Code : 8538					
	Accessories	Wrench for retaining ring Plug for hole Legend plate	TWN TPL 050L^	250 105 45	8538	1

Note: * Position-2 or 3 • Function M-maintained, S-Springreturn ■ Cam code 1/2/3 ^ Suffix Legend Code

Push Button 30.5mm..... BCH

Oil Tight Indicating Light - E 30.5mm HSN Code : 8536

Description	Application	Cat. No.	List Price [₹]	HSN Code	Lot Size
(Without lens) Direct type	AC & DC	TILD•10	365	8536	1
Transformer type	AC	TILT•10	460	8536	1
HSN Code : 8538					
Polycarbonate Lens	-	LENS*	50		10
Spare Bulb	AC & DC	SP61L#	55	8538	1

* Lens available in colours given below # Suffix voltage code lamp

Accessories for indicating light - E 30.5mm HSN Code : 8538

Description	Cat. No.	List Price [₹]	HSN Code	Lot Size
Signal lamp transformer	TR■	265	8538	10
Plastic lens	L2 ⁰	45	8538	1

@ Prices are exclusive of lens

^ Suffix Legend plate code

⁰ Suffix colour code: Milky White 1, Clear 2, Yellow 3, Blue 4, Red 5 & Green 6.

■ For Contact Block, please refer Push Button Type T.

■ The illuminated buttons can be supplied for 6V or 24V direct operations.

■ The Transformers are available in 110/6V, 220/6V, 110/24V & 240/24V

Voltage Code (Direct type lamps)

Volts	6	12	24	48	110	220	240	415
Code	P	S	U	W	A	B	K	M

Voltage Code (Transformer type lamps)

Volts	110/6	110/24	220/6	240/24	415/6
Code	A	A/U	B	K/U	M

Suffix Colour Code - 30.5 mm

Colour	Suffix	Colour	Suffix
Red	1P	Yellow	5P
Green	2P	Clear	7P
Blue	3P		
Amber	4P		

Legend Plate - Suffix Code for E30 & 22.5

Inscription	Start	Stop	Inch	Forward	Reverse	UP	Down	Slow	Fast	Raise	Left	Motor Run	Motor Stop	Overload Tripped	Overload Reset	Power On
Suffix code E22	1	2	3	4	5	6	7	9	10	11	-	-	-	-	-	-
Suffix code Type T	34	35	14	07	41	40	04	33	06	-	18	22	23	30	31	32

Inscription	Stop Reset	Test	Trip	Lower	Off	On	Jog	Emergency Stop	Reset	High	Run	Close	Open	Blank	On-Off
Suffix code E22	-	-	-	12	13	14	15	16	17	19	20	21	22	23	28
Suffix code Type T	36	37	38	-	24	26	-	05	-	12	-	03	27	01	-

Push Button 22.5mm BCH

Push Button & Indicating Lights - 22.5 mm



HSN Code : 8536



Description	Type	Cat. No.	MRP[₹]	Lot Size	
Push Button Actuators with Mounting Adaptor	Opaque	Flush	HEA11*M	90	10
		Extended	HEA12*M	95	
	Illuminated**	Flush	HEB11*M	130	
		Extended	HEB12*M	135	
	Mushroom Head 28mm Colour - Red/Black	Momentary	HEA21*M	115	10
		Twist to Release	HEA23*M	165	
		Stayput Key Release	HEA25*M	325	
		Mushroom Head 40mm Colour - Red/Black	Momentary	HEA22*M	
		Twist to Release	HEA24*M	185	
Light Source Units (LSU)	Basic Unit with Mounting Adaptor	Lamp Holder & Lens	HPL22*	80	10
	LSU with Bulb-Direct Type	6/12/24/48/60/110V ac/dc	HLSUD#	85	
	LSU with Bulb-Resistance Type ■	110V ac/dc & 240V ac	HLSUR#	95	
	LSU with Bulb-Transformer Type @	Primary : 110V/240V/415V ac Secondary : 6 & 12V ac	HLSUT#	305	
LED Indicating Light	Standard 6/12/24/48/60/110/240/415V ac*** 6-60V ac/dc; 110 & 240V dc	Color - R/Y/G/A	HFB2X*#	180	10
		Blue	HFB2XL#	365	1
		Clear	HFB2XC#	505	1
	Universal 24-240V ac/dc	Color - R/Y/G/A	HFB2X*UH4	240	
		Blue	HFB2XLUH4	455	
		Surge Protected 12-60V ac/dc; 110/240/415V ac; 110/240V dc	Color - R/Y/G/A	HFB2S*#	235
	Blue		HFB2SL#	390	1
	Clear		HFB2SC#	545	1
	Low Voltage Glow Protected 110V/240/415V ac	Color - R/Y/G/A	HFB2P*□	270	10
		Blue	HFB2PLH	485	1
Surge & Low Voltage Glow Protected 110V/240/415V ac	Color - R/Y/G/A	HFB2SP*□	275	10	
	Blue	HFB2SPLH	490	1	
Selector Operators with Mounting Adaptor	Selector Key Operator (Color - Black)	2pos Maintained	Pls refer Ordering Sequence & Circuit Combination Table for exact Cat. Ref.	300	1
		2pos Spr Ret R>L		300	
		3pos Maintained		310	
		3pos Spr Ret L>C		310	
		3pos Spr Ret R>C		310	
		3pos Spr Ret L>C<R		310	
	Selector Knob or Lever Opaque	2pos Maintained		245	
		2pos Spr Ret R>L		245	
		3pos Maintained		245	
		3pos Spr Ret L>C		245	
		3pos Spr Ret R>C		245	
		3pos Spr Ret L>C<R		245	
	Selector Knob or Lever Illuminated *	2pos Maintained		260	
		2pos Spr Ret R>L		260	
		3pos Maintained		260	
		3pos Spr Ret L>C		285	
		3pos Spr Ret R>C		285	
		3pos Spr Ret L>C<R		285	

* Colour Code Table 1 # Voltage Code Table 2 @ For extended bulb version, use code HLSUTE#
 ■ Not suitable for illuminated push button types
 ** Light Source Unit (LSU) needs to be ordered separately.
 *** LED indicating light (standard) 550VAC, Prices are available on request.

Push Button 22.5mm

BCH

Push Button - 22.5 mm



HSN Code : 8536



Description	Type	Cat. No.	MRP [₹]	Lot Size
Contact Block		1NO	HCB10	80
		1NC	HCB01	
	Early Make	1NO	HCB10EM	85
	Late Break	1NC	HCB01LB	
		1NO+1NC	HCB11	130
		2NO	HCB20	

Ordering Sequence for Selector Operators

H	E				M
		A - Opaque ; B - Illuminated	Table 3 - Position/Cam	Table 4 - Type	Table 1 Color

HSN Code : 8538

Description	Type	Cat. No.	MRP [₹]	Lot Size
Spares & Accessories	Filament Bulb	Normal Bulb	9ED2#	40
	Filament Bulb	Extended Bulb	9ED3#	40
	Mounting Adaptor		HMR	40
	Lens for Indicating Lamp		H8ED1*	40
	Knob for Illum. Selector Actuator		H9ED1K*	40
	Lever for Illum. Selector Actuator		H9ED1L*	40
	Legend Plate with Std Inscription	Flush/Extended PB	8EA9 +	40
	Rubber Boot for IP66 Protection		HRB*	50
	Padlock to Prevent Operation		8EA1	70

SELECTION CRITERIA FOR

3 POSITION SELECTOR OPERATOR CAM:

Selector Operators with CAM1 :

- When the Selector operator lever / knob is moved to the left side, it operated the left side contact block.
- When the Selector operator lever / knob is moved to the right side, it operates the right side contact block.

Selector Operator with CAM2 :

- When the Selector operator lever / knob is moved to the left side, it operates the left side contact block.
- When the Selector operator lever / knob is moved to the right side, it operates **both the right side contact block and the left side contact blocks.**

* Color Code Table 1 # Voltage Code Table 2 + See Suffix code table on page 42

Suffix Code Tables

Table 1		
Applicable for	(*) Color	Code
Opaque, Illuminated	Red	R
Opaque, Illuminated	Yellow	Y
Opaque, Illuminated	Green	G
Opaque, Illuminated	Blue	L
Opaque	Black	B
Illuminated	Amber	A
Opaque	White	W
Illuminated	Clear	C

Table 3	
Selector Operator Version	Code
Sel. Lever 2 pos	8L
Sel. Key 2 pos	8Y
Sel. Knob 2 pos	8K
Sel. Lever 3 pos Cam1	6L
Sel. Key 3 pos Cam1	6Y
Sel. Knob 3 pos Cam1	6K
Sel. Lever 3 pos Cam2	7L
Sel. Key 3 pos Cam2	7Y
Sel. Knob 3 pos Cam2	7K

Table 4		
Applicable for	Type	Code
Selector Operator	Maintained in All Position	D
Selector Operator	Spring Return Right>Centre	R
Selector Operator	Spring Return Left>Centre	T
Selector Operator	Spr. Return Left>Centre<Right	S

Suffix Code Tables

Table 2		
Applicable for	(*) Voltage	Code
LSU, LED	6V AC/DC (DIRECT)	P4
LSU, LED	12V AC/DC (DIRECT)	S4
LSU, LED	24V AC/DC (DIRECT)	U4
LSU, LED	48V AC/DC (DIRECT)	W4
LSU, LED	60V AC/DC (DIRECT)	Y4
LSU	110V AC/DC (DIRECT)	A4
LSU	110V AC/DC (RESISTOR)	A4
LED	110/120V AC	E
LED	110/120V DC	E1
LED	220/240V AC	H
LED	220/240V DC	H1
LSU	110V/6V (TRANSFORMER)	AP
LSU	110V/24V (TRANSFORMER)	AU
LSU	240V/6V (TRANSFORMER)	KP
LSU	240V/24V (TRANSFORMER)	KU
LSU	415V/6V (TRANSFORMER)	MP
LSU	415V/24V (TRANSFORMER)	MU
LED	415V AC	M
LED	220/240V AC (DIODE+RESISTOR)	H

Note : Key type Sel Operator available in Opaque version & Black color only.

AC Solenoids & Brakes BCH



Range

- Solenoids:
 - Type : SLB - 25 mm stroke length
 - Type : SLD - 31.4 mm stroke length
- AC Brakes
 - 4" Dia
 - 5.5" Dia
 - 7" Dia
- Drums

Features

- Class F insulation of the coil
- Continuous & Intermittent duty
- Long life & ease of maintenance
- Ideally suited for applications such as :
 - Cranes
 - Hoists
 - Machines
 - Valves
 - Conveyers

AC Solenoid - Pull Type

GST to be charged extra

HSN Code : 8505

Type	Stroke Length mm	Max. Pull (Continuous Duty) Kg. mm	Cat. No.	List Price [₹]
B	25.0	1.25	SLB-	3470
D	31.4	6.75	SLD-	5125

* The standard coil voltages are 110, 220 & 415 V 50 Hz. AC

AC Solenoid Brake - Type S

GST to be charged extra

HSN Code : 8505

Type of Brake	Wheel dia.		Max. Torque		Duty	Brake		Drum	
	Inch	Inch	Lb. ft.	Nm		Cat No.	List Price [₹]	Cat No.	List Price [₹]
S-4	4	101.6	10	13.6	Continuous	S-42 ■	9145	AC50D4	1555
S-5	5.5	139.7	25	34.0	Continuous Intermittent	S-51 ■	12910	AC50D5	2150
			35	48.0		S-52 ■			
S-7	7	177.8	50	68.0	Continuous Intermittent	S-71 ■	14975	AC50D7	2475
			75	102.0		S-72 ■			

AC Solenoid Brake - Type S-10



GST to be charged extra

HSN Code : 8505

S-250	9.84	250	109	147.0	Continuous	S-2501*	31670	AC50D25	5005
-------	------	-----	-----	-------	------------	---------	-------	---------	------

- The standard coils are 110, 220 & 415 V 50 Hz. AC

■ To complete Cat. No. suffix voltage code given below

- Brake drums are of standard specification

- For Intermittent duty (S-250 brake), please contact branch office

AC Solenoid Brakes - Voltage Codes

Coil Voltage	110	220	415
AC	A	B	M

Spares For AC Solenoid Brake

GST to be charged extra

HSN Code : 8505

Description	Brake Size : 4"		Brake Size : 5.5"		Brake Size : 7.0"		Brake Size : 10"	
	Cat. No.	List Price [₹]	Cat. No.	List Price [₹]	Cat. No.	List Price [₹]	Cat. No.	List Price [₹]
Brake lining	SP50L1	1165	SP50L2	1730	SP50L3	2320	SP50L4	4555
Brake shoe Assembly*	SP50SA1	3255	SP50SA2	4200	SP50SA3	6930	SP50SA4	13965
Brake Coil -Continuous -Intermittent	SP50MC01	1680	SP50MC21 ■ SP50MC22 ■	3350	SP50MC21 ■ SP50MC22 ■	3350	SP50MC31 ■	8865
Brake Drum	AC50D4	1555	AC50D5	2150	AC50D7	2475	AC50D25	5005

- Prices are per set of 2 nos.,

brake shoe assembly is with lining.

■ To Complete Cat. No. suffix voltage code is given in table, above.

***GST to be charged extra on all AC Brakes & Brake Spares**

DC Brakes BCH



- Shunt and Series type versions in sizes :
 - 8 Inch to 30 Inch
 - 160 mm to 800 mm
- Conforms to NEMA and AISE Standards
- Fail safe operation
- Unique design for maximum torque and minimum shoe wear
Brakes equivalent to Russian 'TKT' design also available
- Resistance & rectifier Panel available with option of 'Fuse' or 'MCB' protection

Proven and time tested

New

Heavy duty encapsulated coil with class 'F' insulation

Optional Features

- Limit Switch Attachment
- Manual Release
- Residual magnetism adjustment

GST to be charged extra

HSN Code : 8505

DC Electromagnetic Brakes

Shunt Type		Torque		Resistance & Rectifier Panel (with fuse protection) ⁺			
Drum Size	Cat No.	Torque	List Price [₹]	Single Brake		2 Brakes Simult. Operation	
		KG-M		Cat No.	List Price [₹]	Cat No.	List Price [₹]
150mm	SMH150	8	39040	CACS1*MAE	41390	CACS2*MAE	57500
160mm	SMH160						
8"/200mm	SMH8	13.8	45955	CACA1*MAE	46140	CACJ2*MAE	59795
	SMH200	13.8					
10"/250mm	SMH10	27.7	56420	CACB1*MAE	48960	CACK2*MAE	67310
	SMH250	27.7					
13"/300mm	SMH13	76.0	92370	CACC1*MAE	52795	CACL2*MAE	78380
	SMH300	76.0					
16"/400mm	SMH16	138.8	148680	CACD1*MAE	60790	CACM2*MAE	85180
	SMH400	138.8					
19"/500mm	SMH19	277.0	237630	CACE1*MAE	73505	CACN2*MAE	107615
	SMH500	277.0					
23"/600mm	SMH23	555.0	379365	CACF1*MAE	94780	CACP2*MAE	136155
	SMH600	555.0					
30"/700mm	SMH30	1242.0	844810	CACG1*MAE	374190	-	-
	SMH700	1242.0					
800mm	SMH800	1242.0	915310	CACG1*MAE	374190	-	-

* For control supply i.e. A=110 V, B=220 V, K =240V and M=415 V AC

1. DC Electromagnetic Brakes are suitable to operate on:

For AC Power - Resistance & Rectifier Panel

For DC Power - Series Resistance Box

+ For Panel with MCB protection use the suffix '- MCB'

eg. For 200mm single operation brake panel with MCB protection,

Cat code will be CACA1*MAE-MCB

Prices of 'Brakes with Asbestos free liners' available on request.

***GST to be charged extra on all DC Brakes, Brake Spares, Resistance & Rectifier Panel & Resistance Boxes**

- All Brakes are Supplied for Continuous Duty

- Resistance & Rectifier Panel is supplied without transformer.

- Control Transformer (Optional) can be supplied at extra cost.

Please add Rs. 5150/- per unit with the LP of Resistance & Rectifier

Panel. Please add 'TR' with respective panel cat. ref. to obtain

final cat. Code of such panel with control transformer.

DC Brakes BCH

Resistance Boxes for DC Electromagnetic Brakes

GST to be charged extra

HSN Code : 8505

Shunt Type			Permanent Series Resistance Box for 230 V DC Supply For Single Brake		Permanent Series Resistance Box for 230 V AC Supply For Single Brake		Permanent Economy Resistance Box for 415 V AC Supply For Single Brake		Permanent Economy Resistance Box for 415 V AC Supply For Double Brake	
Size	Cat No.	Torque KGM	Cat No.	List Price [₹]	Cat No.	List Price[₹]	Cat No.	List Price[₹]	Cat No.	List Price[₹]
150mm	SMH150	8	CDCS101D	5645	CARS10KE	5165	CARS10ME	10425	CARS20ME	On request
160mm	SMH160									
8"/200mm	SMH8	13.8	CDCA101D	5860	CARA10KE	5335	CARA10ME	10425	CARA20ME	On request
	SMH200	13.8	CDIA101D*							
10"/250mm	SMH10	27.7	CDCB101D	6955	CARB10KE	6145	CARB10ME	10425	CARB20ME	On request
	SMH250	27.7	CDIB101D*							
13"/300mm	SMH13	76.0	CDCC101D	8025	CARC10KE	7290	CARC10ME	11935	CARC20ME	On request
	SMH300	76.0	CDIC101D*							
16"/400mm	SMH16	138.8	CDCD101D	8595	CARD10KE	7830	CARD10ME	13870	CARD20ME	On request
	SMH400	138.8	CDID101D*							
19"/500mm	SMH19	277.0	CDCE101D	9200	CARE10KE	8395	CARE10ME	15400	CARE20ME	On request
	SMH500	277.0	CDIE101D*							
23"/600mm	SMH23	555.0	CDCF101D	10480	CARF10KE	9430	CARF10ME	16555	CARF20ME	On request
	SMH600	555.0	CDIF101D*							
30"/700mm	SMH30	1242.0	CDCG101D	25395	-	-	CARG10ME	28565	-	-
	SMH700	1242.0	CDIG101D*							
800mm	SMH800	1242.0	CDIG101D*	25395	-	-	CARG10ME	28565	-	-

1. DC Electromagnetic Brakes are suitable to operate on:
For AC Power - Resistance & Rectifier Panel
For DC Power - Series Resistance Box

- All Brakes are Supplied for Continuous Duty
* These cat. references are meant for intermittent duty

***GST to be charged extra on all DC Brakes, Brake Spares, Resistance & Rectifier Panel & Resistance Boxes.**

DC Brakes BCH

GST to be charged extra

Series Type - DC Electromagnetic Brakes

HSN Code : 8505

Brake Size	Motor Frame No. (Max.)	Half Hour Rating			One Hour Rating			List Price [₹]
		Torque KGM	Max. FLC (A)	Cat. No.	Torque KGM	Max. FLC (A)	Cat. No.	
8"/200mm	402,802A,403, 602, 802B	13.8	29	SME8H1 SME200H1	8.97	21	SME801 SME20001	94685
			44	SME8H2 SME200H2		31	SME802 SME20002	
10"/250mm	404,603,802C, 406,604,803	27.7	57	SME10H1 SME250H1	18.0	40	SME1001 SME25001	135090
			77	SME10H2 SME250H2		57	SME1002 SME25002	
13"/300mm	408,606,804, 410,608,806	76.0	126	SME13H1 SME300H1	49.4	95	SME1301 SME30001	183030
			176	SME13H2 SME300H2		132	SME1302 SME30002	
16"/400mm	412,610,808	138.8	245	SME16H1 SME400H1	90.2	185	SME1601 SME40001	286455
19"/500mm	414,612,810 416,614,812	277.0	368	SME19H1 SME500H1	180.0	272	SME1901 SME50001	440065
			500	SME19H2 SME500H2		360	SME1902 SME50002	
23"/600mm	418,616,814 618,816	555.0	740	SME23H1 SME600H1	361.0	540	SME2301 SME60001	711980
			960	SME23H2 SME600H2		730	SME2302 SME60002	

- During ordering, besides brake drum dia, please confirm duty rating, current rating & motor frame Nos.
- Above current ratings are for 230 V DC Series Motors.
- To convert KGM to LB.FT. multiply by 7.25

***GST to be charged extra on all DC Brakes, Brake Spares, Resistance & Rectifier Panel & Resistance Boxes.**

GST to be charged extra

Series & Accessories - DC Electromagnetic Brakes

HSN Code : 8505

Description	150/160mm		8"/200mm		10"/250mm		13"/300mm	
	Cat No.	List Price [₹]	Cat No.	List Price [₹]	Cat No.	List Price [₹]	Cat No.	List Price [₹]
 Coil Shunt	9GDS01	26605	9GDA01	28990	9GDB01	34480	9GDC01	55620
 Coil Series for inch for mm	-	-	9GDA02/ 9GDA03	70100	9GDB02/ 9GDB03	109880	9GDC02/ 9GDC03	142105
 Torque Adj. Screw Assembly	9GDS04	2530	9GDA04	2635	9GDB04	2635	9GDC04	4600
 Torque Spring	9GDS05	6890	9GDA05	7200	9GDB05	8500	9GDC05	13770
 Wedge Assembly with Bolt, Spring and Washers for inch/mm	9GDS20/ 9GDS22	975	9GDA20/ 9GDA22	1120	9GDB20/ 9GDB22	1305	9GDC20/ 9GDC22	1990
 Pin set for Lever & Armature Consisting of a) Pin Lever 2 Nos. b) Pin armature 2 Nos.	9GDS06	3470	9GDA06	3640	9GDB06	3640	9GDC06 9GDC06-2#	4600
 Coller Set of Lever & Armature Consisting of a) Coller Lever 4 Nos. a) Coller Armature 4 Nos.	9GDS07	3470	9GDA07	3640	9GDB07	3640	9GDC07	4365
 Bush Set for Lever & Armature Consisting of a) Bush Lever 4 Nos. a) Bush Armature 4 Nos.	9GDS08	6890	9GDA08	7230	9GDB08	7230	9GDC08	7875
 Pull Rod Assembly with nuts, spring & washer	9GDS29	2815	9GDA29	2945	9GDB29	3640	9GDC29	5605
 Grease Nipple (1 set consist 8 Nos.)	9GDS09	975	9GDA09	1035	9GDB09	1035	9GDC09	1040
 * Shoe Assembly with Clamp & Bolts (1 set consist 2 Nos.) for inch/mm	9GDS10/ 9GDS11	7175	9GDA10/ 9GDA11	7175	9GDB10/ 9GDB11	8865	9GDC10/ 9GDC11	13770
 * Shoe Lining without Bolts for inch for mm (1 set consist 2 Nos.)	9GDS12/ 9GDS13	2425	9GDA12/ 9GDA13	2530	9GDB12/ 9GDB13	3180	9GDC12/ 9GDC13	4600
 * Shoe Lining with Bolts for inch for mm (1 set consist 2 Nos.)	9GDS23/ 9GDS26	3285	9GDA23/ 9GDA26	3640	9GDB23/ 9GDB26	4600	9GDC23/ 9GDC26	6570
 Dust Cover (made of jeans cloth & painted with fire reterdent al. paint).	-	-	9GDA30	4050	9GDB30	4050	9GDC30	4825
 mm Size Cast Steel Drum without Hard Chrome Plaiting	9GDS14	7845	9GDA14	8635	9GDB14	13295	9GDC14	22410
mm Size Cast Steel Drum with Hard Chrome Plaiting	9GDS14P	10600	9GDA14P	12360	9GDB14P	19305	9GDC14P	32475
Cast Steel Drum without Hard Chrome Plaiting* for inch	-	-	9GDA15	8950	9GDB15	13780	9GDC15	23305
Cast Steel Drum with Hard Chrome Plaiting* for inch	-	-	9GDA15P	12850	9GDB15P	19510	9GDC15P	33800

* For brakes manufactured upto September 07. # For brakes manufactured after September 07 (pins are different).

* Prices of 'Asbestos free' Shoe Assembly / Shoe Lining without Bolt / Shoe Lining with Bolt available on request.

***GST to be charged extra on all DC Brakes, Brake Spares, Resistance & Rectifier Panel & Resistance Boxes.**

DC Brakes..... BCH

GST to be charged extra

Spares & Accessories - DC Brakes

HSN Code : 8505

Description	16"/400 mm		19"/500 mm		23"/600 mm		30"/700 mm/800mm	
	Cat No.	List Price [₹]	Cat No.	List Price [₹]	Cat No.	List Price [₹]	Cat No.	List Price [₹]
Coil Shunt	9GDD01	84225	9GDE01	116765	9GDF01	186590	9GDG01	416090
Coil Series for inch for mm	9GDD02 9GDD03	209085	9GDE02 9GDE03	272735	9GDF02 9GDF03	421600	-	-
Torque Adj. Screw Assembly	9GDD04	6870	9GDE04	9800	9GDF04	15670	9GDG04	32835
Torque Spring	9GDD05	21165	9GDE05	29295	9GDF05	48505	9GDG05	104115
Wedge Assembly with Bolt, for inch for mm Spring and Washers	9GDD20/ 9GDD22	2635	9GDE20/ 9GDE22	3960	9GDF20/ 9GDF22	6220	9GDG20/ 9GDG22	13790
Pin set for Lever & Armature Consisting of a) Pin Lever 2 Nos. for inch for mm b) Pin Armature 2 Nos.	9GDD06* 9GDD06-2#	5605	9GDE06* 9GDE06-2#	5605	9GDF06* 9GDF06-2#	7875	9GDG06 ⁺⁺	23850
Coller Set of Lever & Armature Consisting of a) Coller Lever 4 Nos. b) Coller Armature 4 Nos.	9GDD07	4365	9GDE07	4385	9GDF07	5355	9GDG07 ⁺	8795
Bush Set for Lever & Armature Consisting of a) Bush Lever 4 Nos. b) Bush Armature 4 Nos.	9GDD08	8060	9GDE08	8445	9GDF08	10805	9GDG08 ⁺⁺	19230
Pull Rod Assembly with nuts, spring & washer	9GDD29	8500	9GDE29	11765	9GDF29	15810	9GDG29	41380
Grease Nipple (1 set consist 8 Nos.)	9GDD09	1065	9GDE09	1845	9GDF09	1845	9GDG09	2030
Shoe Assembly with Clamp & Bolts for inch (1 set consist 2 Nos.) for mm	9GDD10/ 9GDD11	21200	9GDE10/ 9GDE11	27280	9GDF10/ 9GDF11	46895	9GDG10/ 9GDG11 ⁺⁺⁺ 9GDG11A ⁺⁺⁺	104115 108840
Shoe Lining without Bolts for inch (1 set consist 2 Nos.) for mm	9GDD12/ 9GDD13	7210	9GDE12/ 9GDE13	11765	9GDF12/ 9GDF13	17405	9GDG12/ 9GDG13 ⁺⁺⁺ 9GDG13A ⁺⁺⁺	32905 34500
Shoe Lining with Bolts for inch (1 set consist 2 Nos.) for mm	9GDD23/ 9GDD26	8865	9GDE23/ 9GDE26	14675	9GDF23/ 9GDF26	22805	9GDG23/ 9GDG26 ⁺⁺⁺ 9GDG26A ⁺⁺⁺	40695 44210
Dust Cover (made of jeans cloth & painted with fire reterdent al. paint).	9GDD30	5220	9GDE30	6460	9GDF30	6770	-	-
mm Size Cast Steel Drum without Hard Chrome Plaiting	9GDD14	28015	9GDE14	45000	9GDF14	63455	-	-
mm Size Cast Steel Drum with Hard Chrome Plaiting	9GDD14P	41720	9GDE14P	65730	9GDF14P	97075	-	-
Cast Steel Drum without Hard Chrome Plaiting* for inch	9GDD15	29220	9GDE15	47105	9GDF15	65190	-	-
Cast Steel Drum with Hard Chrome Plaiting* for inch	9GDD15P	43605	9GDE15P	68920	9GDF15P	101725	9GDG15P	172355

* For brakes manufactured upto September 07. # For brakes manufactured after September 07 (pins are different).
+ Consist of strap, Brass Shim & spring Plate ++ Only for Armature +++ Suitable for 800mm

***GST to be charged extra on all DC Brakes, Brake Spares, Resistance & Rectifier Panel & Resistance Boxes.**

Spares - DC Brakes BCH

GST to be charged extra

Spare Selenium Type Bridge Rectifiers

HSN Code : 8505

Rectifier Code / Part No.	Recommended to operate brake at 415V AC		Qty. per set	List Price [₹]
	Individual	Simultaneous		
9GDX01	1x8"/200mm	-	2	8170
9GDX02	1x10"/250mm	2x8"/200mm	2	12750
9GDX03	1x13"/300mm 1x16"/400mm	2x10"/250mm	2	17270
9GDX04	1x19"/500mm	2x13"/300mm 2x16"/400mm	2	22805
9GDX05	1x23"/600mm	2x19"/500mm	2	32530
9GDX06	-	2x23"/600mm	2	65095
9GDX07	1x30"/700 & 800mm	-	2	90260

GST to be charged extra

Spare Resistances

HSN Code : 8505

Cat. No.	Ohms	Watts	List Price [₹]
9GDX32	32	200	1505
9GDX42	42	200	
9GDX47	47	200	
9GDX52	52	200	
9GDX64	64	100	
9GDX80	80	200	
9GDX112	112	200	
9GDX112A	112	125	

GST to be charged extra

Optional Features - DC Brakes

HSN Code : 8505

Brakes Size		Manual Release List Price [₹]	Residual Magnetism Adjustment List Price [₹]	Limit Switch Attachment List Price [₹]	
Inch	mm			1NO+1NC (LSA)	2NO+2NC (LSA-2)
8	150/160/200	3375	6515	6865	
10	250	3375			
13	300	4620			
16	400	4960			
19	500	7640			
23	600	10800			

Note : Suffix following codes to complete brakes code with optional features.

- MR = For Manual Release
- RM = For Residual Magnetism
- LS = For Limit Switch (1NO+1NC)
- LS-1 = For Limit Switch (2NO+2NC)
- RR = For Manual Release + Residual Magnetism
- RL = Residual Magnetism + Limit Switch
- ML = For Manual Release + Limit Switch
- RS = For Manual Release + Residual Magnetism + Limit Switch

To order Spare Limit Switch assembly, cat codes are:

- LSA = Limit Switch with fitting Arrangement (1NO + 1NC)
- LSA -2 = Limit Switch (2NO + 2NC) with fitting Arrangement

***GST to be charged extra on all DC Brakes, Brake Spares, Resistance & Rectifier Panel & Resistance Boxes.**

Plugs & Sockets BCH



Metal Clad - Plugs & Sockets Type 'MP' & 'MS'

HSN Code : 8536

Rating	Pins	Type	Cat No.	MRP [₹]
20A, 250V	2P + E	Plug	MP20	185
		Socket	Ms20	205
30A, 440V	3P + E	Plug	MP30	425
		Socket	Ms30	425



Plastic Plugs & Socket Type 'PS'

HSN Code : 8536

Rating	Pins	Type	Cat No.	MRP [₹]
20A, 250V	3	Plug	PS16AA7	200
		Flush Mounting Socket	PS16BA7	265
		Socket with Wall Mounting Box	PS16DA7	325
20A, 415V	4	Plug	PS16AA1	250
		Flush Mounting Socket	PS16BA1	350
		Socket with Wall Mounting Box	PS16DA1	405
32A, 415V	3	Plug	PS32AA7	460
		Socket	PS32BA7	460
	4	Plug	PS32AA1	485
		Socket	PS32BA1	485
	5	Plug	PS32AA5	510
		Socket	PS32BA5	510

- Self Locking design : Extremely safe
- Plug cannot be pulled out in fully engaged position
- Auto closing socket shutter
- Reliable Earthing
- Shrouded Terminals for safety

Heavy duty Metal-Control 'SS'



Heavy Duty Metal - Control Plugs & Sockets Type 'SS'

HSN Code : 8536

Rating	Pins	Type	Cat No.	MRP [₹]
12A, 415V (Control)	12	Panel Mounting Socket	2499/12	1205
		Plug with inclined Handle	299/12B	1205

Heavy duty Metal-Power 'SS'



Heavy Duty Metal - Power Plugs & Sockets Type 'SS'

HSN Code : 8536

Rating	Pins	Type	Cat No.	MRP [₹]
30A, 415V	3	Panel Mounting Socket	2415B	665
		Plug with inclined Handle	215B	665
30A, 415V	4	Panel Mounting Socket	2413B	690
		Plug with inclined Handle	213B	690
30A, 415V	5	Panel Mounting Socket	2417B	725
		Plug with inclined Handle	217B	725

Note : *Loose Conduit Box Straight (Cat. No. 9J101) MRP - Rs. 240/- each
 *Spare Handle Inclined (Cat. No. 9J108) MRP -Rs. 115/- each. } HSN Code : 8538

Plugs & Sockets BCH

Heavy Duty Metal Plug & Sockets Type 'DS' - 5 Pin (with Integral Switching Device)

HSN Code : 8536

Rating	Pins	Type	Cat No.	MRP [₹]
16A, 415V	5	Plug	DS1A7A1	1000
		Socket	DS1B7A1	1240
		Handle Assembly	SP91PH	155
32A, 415V	5	Plug	DS3A7A1	1755
		Socket	DS3B7A1	2195
		Handle Assembly	SP93PH	165
63A, 415V	5	Plug	DS6A7A1	2805
		Socket	DS6B7A1	3620
		Handle Assembly	SP96PH	240
125A, 415V	5	Plug	DS9A7A1	8190
		Socket	DS9B7A1	11480
		Conduit Box	SP99WB	5805
		Handle Assembly	SP99PH	730

Note : Power Receptacles with or without SFU/SDFU/MCB/MCCB having loop-in / loop-out facility is available on request.



- Range from 16A to 125 A
- 5 Pin configuration (3P+N+E)
- Plug cannot come out in ON condition (Integral Interlocking)

- Spring loaded Butt type contacts
- Self aligning and self wiping

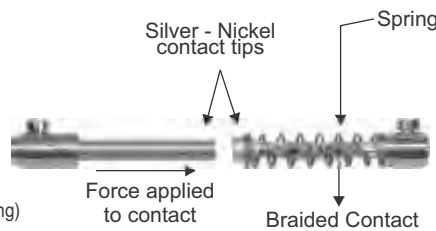

Quick Disconnect



*Sparkless
Butt type contact*



- Self aligning self wiping
- Spring loaded for consistent pressure
- Silver nickle material for extremely low temperature rise

Safety Disk



No access to live parts

Vibration proof termination



Plug & Socket Box BCH

Metal Clad - Plug & Socket Box Type 'MPSEU'

HSN Code : 8536

Rating	Pins	Mounting	Type	Cat No.	MRP [₹]
20A, 250V	2P + E	Universal	Plug & Socket Box - SP-MCB Cutout	MPSEU201	920
20A, 250V	2P + E	Universal	Plug & Socket Box - DP-MCB Cutout	MPSEU202	920
30A, 440V	3P + E	Universal	Plug & Socket Box - TPN-MCB Cutout	MPSEU301	2275



Plastic - Plug & Socket Box Type 'PSEU / PSEF'

HSN Code : 8536



Rating	Pins	Mounting	Type	Cat No.	MRP [₹]
20A, 250V	3	Universal	Plug & Socket Box with SP MCB Cutout	PSEU201	1065
			Plug & Socket Box with DP-MCB Cutout	PSEU202	1095
		Flush	Plug & Socket Box with SP MCB Cutout	PSEF201	1065
			Plug & Socket Box with DP-MCB Cutout	PSEF202	1095
32A, 415V	4	Universal	Plug & Socket Box with 4P MCB Cutout	PSEU324	2395
			Plug & Socket Box with 4P MCB Cutout	PSEU325	2445
	5	Flush	Plug & Socket Box with 4P MCB Cutout	PSEF324	2395
			Plug & Socket Box with 4P MCB Cutout	PSEF325	2445

Heavy Duty Metal - Plug & Socket Box Type 'SSEU'

HSN Code : 8536

Rating	Pins	Mounting	Type	Cat No.	MRP [₹]
30A, 415V	3	Universal	Plug & Socket Box with SP MCB Cutout	SSEU305-MCB1P	2710
			Plug & Socket Box with DP MCB Cutout	SSEU303	2710
	4	Universal	Plug & Socket Box with 4P MCB Cutout	SSEU304	2775
			Plug & Socket Box with 4P MCB Cutout	SSEU305	2840

Stainless Steel Cover Plug & Socket Box Type 'PSEU-SSC'/SSEU-SSC'

HSN Code : 8536

Rating	Pins	Mounting	Type	Cat No.	MRP [₹]
20A, 250V 32A, 415V	3	Universal	P&S Box with 'PS' P&S and SP MCB Cutout	PSEU201-SSC	1365
	5		P&S Box with 'PS' P&S and 4P MCB Cutout	PSEU325-SSC	2800
30A, 415V	3	Universal	Plug & Socket Box with SP MCB Cutout	SSEU303-SSC-MCB1P	3115
	3		Plug & Socket Box with DP MCB Cutout	SSEU303-SSC	3115
	4	Universal	Plug & Socket Box with 4P MCB Cutout	SSEU304-SSC	3185
			5	Plug & Socket Box with 4P MCB Cutout	SSEU305-SSC

Pneumatic Timers..... BCH

Pneumatic Timer



Timer for Railway Application



- 30 sec / 60 sec/180 sec
- AC and DC Supply
- 1 NO+1NC / 2 NO+2NC Contact Blocks
- Completely enclosed timing head ensures excellent timings in adverse environmental conditions
- Encapsulated coil for better resistance against moisture and corrosion
- Completely maintainable i.e Coil , Contact blocks and Timing head can be replaced
- Special timer for Railway application



Pneumatic Timers Time Delay Relay-Electro Pneumatic

HSN Code : 9107

Type	Time (Secs.)	Contact Configuration		Cat No.	MRP [₹]	
		Time Block	Instantaneous Block		AC	DC
PN	30	1NO + 1NC	-	KRTPN10 [■] -0	3405	5100
	60	1NO + 1NC	-	KRTPN10 [■] -1	3520	5390
	180	1NO + 1NC	-	KRTPN10 [■] -3	3980	5880
	30	2NO + 2NC	-	KRTPN20 [■] -0	3825	5465
	60	2NO + 2NC	-	KRTPN20 [■] -1	3910	5530
	180	2NO + 2NC	-	KRTPN20 [■] -3	4200	5940
PNI	30	1NO + 1NC	1NO + 1NC	KRTPN11 [■] -0	4150	5945
	60	1NO + 1NC	1NO + 1NC	KRTPN11 [■] -1	4715	6490
	180	1NO + 1NC	1NO + 1NC	KRTPN11 [■] -3	5155	6575
	30	2NO + 2NC	2NO + 2NC	KRTPN22 [■] -0	5205	6785
	60	2NO + 2NC	2NO + 2NC	KRTPN22 [■] -1	5260	7140
	180	2NO + 2NC	2NO + 2NC	KRTPN22 [■] -3	5640	7550
		On-Delay Block	Of-Delay Block			
PCN	30	1NO + 1NC	1NO + 1NC	KRTPCN11 [■] -0	5625	7535
	60	1NO + 1NC	1NO + 1NC	KRTPCN11 [■] -1	5910	7595
	180	1NO + 1NC	1NO + 1NC	KRTPCN11 [■] -3	6710	8395
	30	2NO + 2NC	2NO + 2NC	KRTPCN22 [■] -0	6330	8265
	60	2NO + 2NC	2NO + 2NC	KRTPCN22 [■] -1	6625	8370
	180	2NO + 2NC	2NO + 2NC	KRTPCN22 [■] -3	7475	9125

PN, PNI Time Delay Relay will be supplied only as on-delay

- To complete Cat. No. Suffix Voltage code from Table

Timer for Railway Application

HSN Code : 9107

Type	Time (Secs.)	Contact Configuration		Cat No.	MRP [₹]	
		Time Block	Instantaneous Block		AC	DC
PN	120	2NO + 2NC	-	KRTPN20A-2R	4095	-
	150	2NO + 2NC	-	KRTPN20A-3R	4095	-

^ 110V AC coil voltage, without knob

Accessories for Time Delay Relay HSN Code : 9107

Description	Cat. No.	MRP [₹]	Lot Size
Contact Block			
1NO+1NC Timed	SP20S3+	770	1
2NO+2NC Timed	SP20S4+	1010	
1NO+1NC Inst.	SP20S5+	770	
2NO+2NC Inst.	SP20S6+	1010	
Magnet Coil			
AC-PN Relays	SP20MC [■]	955	1
AC-PNI & PCN Relays	SP20MC1 [■]	955	
DC Relays	SP20MC2 [■]	3120	
Return Spring*			
(PNI & PCN)	SP20RS	175	1
Coil Clip*	SP20CC	285	
Magnet frame assembly without coil	SP20 MA/MA1	1585	1
Knob assembly	SP20KA	45	10

- + These are supplied with plastic cover
- * For DC Timers only
- To complete suffix voltage code refer to the table

- High Repeat Accuracy
- Operating Temperature - 40° to +65°
- Mechanical and Electrical Life - 10 million operations

Voltage Sux Code

Coil Voltage	24	110	220	240	415
AC Suffix M Code*	U	A	B	K	M
DC Suffix - Code	U1	A1	B1	K1	-

* KRTPN timers with 550V AC coil voltage, Prices available on request

Motor Starters BCH

Direct On Line Starters



- DOL upto 40 HP
- Heavy duty 4 Pole Contactor
- Wide Band Coil Voltages (190-400V, 230-420V, 220-240V, 380-415V)
- Encapsulated & Hermetically sealed coil
- Easy inspection & maintenance

Auto Start Direct on line Starters

- Automatically starts the Motor when the power comes back
- Upto 24 A relay rating
- Time delay before restart to settle power supply fluctuations
- Monitors power supply condition before restarting
- Protection against single phasing, phase imbalance & phase reversal



Star Delta Starters



- Semi Automatic upto 40 HP
- Fully Automatic upto 375 HP
- Wide Band Coil Voltages (230-360V, 260-400V, 380-415V)
- Single Phase & Overload Protection

Mini Manual Starters

- Range : 3 - Ph : upto to 10 HP
 : 1 - Ph : upto 4 HP
- Proven time tested product
- Flush and base mounting



Mini Manual with UVT coil



- Automatic Version of Mini Manual Starter
- Prevents motor from restarting when power comes back
- Trips the starter automatically in low voltage conditions

Manual Star Delta Starters

- Contactor based superior design with 25 A heavy duty switch
- Momentary Star position ensures perfect transition
- Ideal for Oil Mills, Flour Mills and agro industries



Motor Starters - Shakti BCH

Shakti WP DOL Starter (190-400V AC Coil)

HSN CODE : 8536



Cat Code	Overload Relay Range (A)	Contactor Type	Contactor rating	MRP [₹]	Cat Code (Open Execution)	MRP [₹]
SAWPGZA	2.4 - 3.8	Shakti	12 A	2270	-	-
SAWPHZA	3.8 - 6.0			2270		
SAWPJZA	6.0 - 9.3			2270		
SAWPGZ	2.4 - 3.8		20 A	2305	SAWPGZI	2260
SAWPHZ	3.8 - 6.0			2305	SAWPHZI	2260
SAWPJZ	6.0 - 9.3			2305	SAWPJZI	2260
SAWPKZ	8.9 - 13.5			2305	SAWPKZI	2260
SAWPLZ	13.2 - 20.0			2450	SAWPLZI	2365
SAWPMZ	17.4 - 24.0			2575	SAWPMZI	2480

Shakti WP DOL Starter (Big Enclosure)

HSN CODE : 8536



Cat Code	Overload Relay Range (A)	Contactor Type	Contactor rating	MRP [₹]
SAWPKZ-BT	8.9 - 13.5	Shakti	20 A	2965
SAWPLZ-BT	13.2 - 20.0			3115
SAWPMZ-BT	17.4 - 24.0			3275

Shakti DOL Starter (190-400V AC Coil)

HSN CODE : 8536



Cat Code	Overload Relay Range (A)	Contactor Type	Contactor rating	MRP [₹]	Cat Code (Open Execution)	MRP [₹]
SAGZ	2.4 - 3.8	Shakti	20 A	2455	SAGZI	2395
SAHZ	3.8 - 6.0			2455	SAHZI	2395
SAJZ	6.0 - 9.3			2455	SAJZI	2395
SAKZ	8.9 - 13.5			2455	SAKZI	2395
SALZ	13.2 - 20.0			2675	SALZI	2625
SAMZ	17.4 - 24.0			2785	SAMZI	2730

Shakti Semi Automatic Star Delta Starter with 260-400V AC Coil

HSN CODE : 8536



Cat Code	Overload Relay Range (A)	Contactor Type	Contactor rating	MRP [₹]
SASSGLEG	2.4 - 3.8	Shakti	16 A	7640
SASSHLEG	3.8 - 6.0			7640
SASSJLEG	6.0 - 9.3			7640
SASSKLEG	8.9 - 13.5			7640
SASSKLEG/LOR	13.2 - 20.0			7795
SASSKLEG-M	17.4 - 24.0			8055

For 380 - 415 V Coil Voltage replace Suffix 'G' by 'N'

Shakti Fully Automatic Star Delta Starter with 260-400V AC Coil & Electronic Timer

HSN CODE : 8536

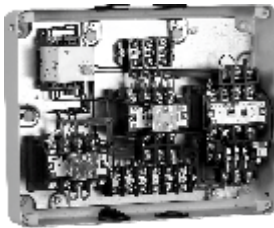

Cat Code	Overload Relay Range (A)	Contactor Type	Contactor rating	MRP [₹]
SASAGLEG	2.4 - 3.8	Shakti	16 A	8660
SASAHLEG	3.8 - 6.0			8660
SASAJLEG	6.0 - 9.3			8660
SASAKLEG	8.9 - 13.5			8660
SASAKLEG/LOR	13.2 - 20.0			8810
SASAKLEG/MOR	17.4 - 24.0			9060

For 380 - 415 V Coil Voltage replace Suffix 'G' by 'N'

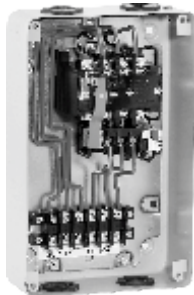

Shakti Auto-Start DOL Starter (With 5-Sec delay Auto Switch)

HSN CODE : 8536



3 Position Selection (Maunal - Manual SPP - Auto)		Description			MRP [₹]
Cat Code	Overload Relay Range (A)	Contactor Type	Contactor rating		
ASXGZ	2.4 - 3.8	Shakti	20 A	3825	
ASXHZ	3.8 - 6.0			3825	
ASXJZ	6.0 - 9.3			3825	
ASXKZ	8.9 - 13.5			3825	
ASXLZ	13.2 - 20.0			4010	
ASXMZ	17.4 - 24.0			4245	

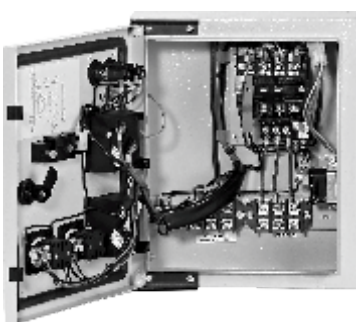

Shakti DOL Submersible Pump Starter (with Auto Switch)

HSN CODE : 8536



3 Position Selection (Maunal - Manual SPP - Auto)		Description			MRP [₹]
Cat Code	Overload Relay Range (A)	Contactor Type	Contactor Rating		
CPEYSAGZ	2.4 - 3.8	Shakti	20 A	6890	
CPEYSAHZ	3.8 - 6.0			6890	
CPEYSAJZ	6.0 - 9.3			6890	
CPEYSAKZ	8.9 - 13.5			6890	
CPEYSALZ	13.2 - 20.0			7490	
CPEYSAMZ	17.4 - 24.0			7880	

For 380 - 415 V coil voltage replace suffix "Z" with "N" in the Cat. Code

For Auto switch with 5 min time delay option, kindly contact nearest sales office

Motor Starters - Citation BCH

Citation DOL Motor Starter

HSN CODE : 8536



Cat Code	HP / KW at 3Ø, 415V, 50Hz	Overload Relay Range (A)	Contactor Type	Contactor Rating	MRP [₹]	Cat Code (Open Execution)	MRP [₹]
NADLEN	0.5 / 0.37	0.72 - 1.14	C00N	16 A	3245	NADLENI	3175
NAELEN	0.75 / 0.55	1.07 - 1.70			3245	NAELENI	3175
NAFLEN	1 / 0.75	1.58 - 2.50			3245	NAFLENI	3175
NAGLEN	2 / 1.5	2.4 - 3.8			3245	NAGLENI	3175
NAHLEN	3 / 2.2	3.8 - 6.0			3245	NAHLENI	3175
NAJLEN	5 / 3.7	6.0 - 9.3			3245	NAJLENI	3175
NAKLEN	7.5 / 5.5	8.9 - 13.5			3245	NAKLENI	3175
NALLEN	10 / 7.5	13.2 - 20.0	3440	NALLENI	3325		
NALLEN/MOR	12.5 / 10	17.4 - 24.0	CP20	20 A	4125	NALLENI/MOR	4050

Citation DOL Motor Starter

(A) with NHD Contactor

HSN CODE : 8536



Cat Code	HP / KW at 3Ø, 415V, 50Hz	Overload Relay Range (A)	Contactor Type	Contactor Rating	MRP [₹]
NAMLEN	15 / 11	17.4 - 24.0	N0N	25A	5150
NAPLEN/MOR	15 / 11	17.4 - 24.0	N01N	32A	6970
NAPLEN	20 / 15	23.0 - 32.0	N01N	32A	7525
NANLEN	20 / 15	22.0 - 30.0	N1N	40A	8325
NACT1LEN	25 / 18.5	24.4 - 39.0	N1N	40A	12775

(B) With Citation Contactor



Cat Code	HP / KW at 3Ø, 415V, 50Hz	Overload Relay Range (A)	Contactor Type	Contactor Rating	MRP [₹]
NACT2LEDM	30 / 22	37.6 - 60.0	Citation D	40A	15500
NACT2LEEM	40 / 30	37.6 - 60.0	Citation E	70A	19420

Citation Semi Automatic Star Delta Starter with NHD Contactor

HSN CODE : 8536

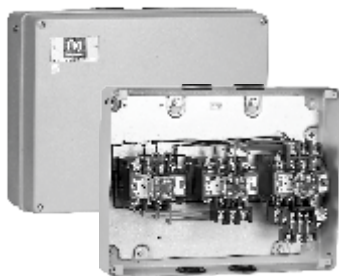

Cat Code	HP / KW at 3Ø, 415V, 50Hz	Overload Relay Range (A)	Contactor Type	Contactor Rating	MRP [₹]
NASSGLEN	3 / 2.2	2.4 - 3.8	C00N	16A	7965
NASSHLEN	5 / 3.7	3.8 - 6.0			7965
NASSJLEN	10 / 7.5	6.0 - 9.3			7965
NASSKLEN	15 / 11	8.9 - 13.5			7965
NASSKLEN/LOR	15 / 11	13.2 - 20.0			8175
NASSLLEN	20 / 15	13.2 - 20.0	N0N	25A	11880
NASSMLEN	25 / 18.5	17.4 - 24.0			11955
NASSPLEN	25 / 18.5	23.0 - 32.0			12870
NASS01PLEN	35 / 26	23.0 - 32.0	N01N	32A	14870
NASSNLEN	35 / 26	22.0 - 30.0	N1N	40A	21365
NASS01CT1LEN	40/30	24.4 - 39.0	N01N	32A	22330

Note : For other Coil Voltages refer table on page 24

Citation Fully Automatic Star Delta Starter with NHD Contactor & Pneumatic Timers

HSN CODE : 8536

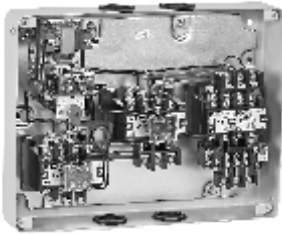

Cat Code	HP / KW at 3Ø, 415V, 50Hz	Overload Relay Range (A)	Contactor Type	Contactor Rating	MRP [₹]
NASAGLEN	3 / 2.2	2.4 - 3.8	C00N	16A	11825
NASAHLEN	5 / 3.7	3.8 - 6.0			11825
NASAJLEN	10 / 7.5	6.0 - 9.3			11825
NASAKLEN	15 / 11	8.9 - 13.5			11825
NASAKLEN/LOR	15 / 11	13.2 - 20.0			11990
NASALLEN	20 / 15	13.2 - 20.0	N0N	25A	13670
NASAMLEN	25 / 18.5	17.4 - 24.0			13745
NASAPLEN	30 / 22	23.0 - 32.0			14315
NASA01PLEN	35 / 26	23.0 - 32.0	N01N	32A	17130
NASANLEN	35 / 26	22.0 - 30.0	N1N	40A	24030
NASACT1LEN	40 / 30	24.4 - 39.0			28535

Note : For other Coil Voltages refer table on page 24

Citation Fully Automatic Star Delta Starter with Citation M Contactor & Pneumatic Timers

HSN CODE : 8536



Cat Code	HP / KW at 3Ø, 415V, 50Hz	Overload Relay Range (A)	Contactor Type	Contactor Rating	MRP [₹]
NASACT1LEDM	40 / 30	24.4 - 39.0	D	40A	34565
NASACT2LEDM	50 / 37	37.6 - 60.0			35115
NASACT2LEEM	75 / 55	37.6 - 60.0	E	70A	60035
NASACT3LEEM	85 / 65	56.4 - 90.0			63855
NASACT3LEEC5M	100 / 75	56.4 - 90.0	M-5	110A	82330
NASACT4LEEC5M	135 / 100	84.6 - 135.0			84175
NASACT4LENM	150 / 110	84.6 - 135.0	N	140A	98590
NASACT5LEEC6M	250 / 185	131.6 - 210.0	S	300A	157025
NASACT6LEEC6M	375 / 280	188.0 - 300.0			177630

Note : For other Coil Voltages refer table on page 24

DOL Reversing Starter

HSN CODE : 8536



Cat Code	HP / KW at 3Ø, 415V, 50Hz	Overload Relay Range (A)	Contactor Type	Contactor Rating	MRP [₹]
NARFLEN	1/0.75	1.58 - 2.50	C00N	16 A	8590
NARGLEN	2/1.5	2.4 - 3.8			8590
NARHLEN	3/2.2	3.8 - 6.0			8590
NARJLEN	5/3.7	6.0 - 9.3			8590
NARKLEN	7.5/5.5	8.9 - 13.5			8590
NARLLEN	10/7.5	13.2 - 20.0	N0N	25 A	10495
NARMLLEN	15/11	17.4 - 24.0	N1N	40 A	11760
NARNLEN	20/15	22.0 - 30.0			17275

Motor Starters - Citation..... BCH

Fully Automatic Automatic Star Delta Starter with Citation M Contactor, Pneumatic Timer & Electronic Over Current Relay with Ammeter & Voltmeter

HSN CODE : 8536



Cat Code	HP / KW at 3Ø, 415V, 50Hz	EOCR Range (A)	Contactor Type (Citation)	Contactor Rating (A)	MRP [₹]
NASASS60LEDM-P	50 / 37	5-60 Amp	D	40A	37765
NASASS60LEEM-P	75 / 55	5-60 Amp	E	70A	62870
NASA2CTD1CLEM5M-P	100/ 75	0.5-6 Amp	M-5	110A	89900

Motor Starters - Freedom.....

Industrial DOL Starters with Freedom Contactor & Overload Relay

HSN CODE : 8536



Cat Code	HP / KW at 3Ø, 415V, 50Hz	Overload Relay Range (A)	Contactor Type	Contactor Rating	MRP [₹]
CEBFM	0.5/0.37	1.0-1.4	Freedom	9 A	2375
CEBGM	0.75/0.55	1.3-1.8	Freedom	9 A	2375
CEBHM	1.0/0.75	1.7-2.4	Freedom	9 A	2375
CEBJM	1.5/1.1	2.2-3.1	Freedom	9 A	2375
CEBKM	2.5/1.5	2.8-4.0	Freedom	9 A	2375
CEBMM	3.0/2.2	4.5-6.5	Freedom	9 A	2375
CEBPM	5.0/3.7	7.5-11	Freedom	9 A	2375
CECPM	5.0/3.7	7.5-11	Freedom	12 A	2430
CECQM	7.5/5.5	10-14	Freedom	12 A	2430
CEDQM	7.5/5.5	10-14	Freedom	18 A	3080
CEDRM	10/7.5	13-19	Freedom	18 A	3080

For other coil voltages, kindly refer coil master table on page 24

Wireless Modem.....



**Wireless Modem
(Compatible With The Complete BCH Starter Family)**

HSN Code : 8517 62 30

Cat Code	Description	MRP [₹]
BCH-GSM	Wireless Modem	5690

1- Phase Mini Manual Motor Starter upto 4HP (Surface Mounting)

HSN CODE : 8536



Cat Code	Recommended HP 1Ø, 240V	Overload Relay Range (A)	MRP [₹]	Cat Code (with UV Coil)	MRP [₹]
AMLE-10-SP	-	0.23 - 0.47	1000	AMLEH-10-SP	1345
AMLE-20-SP	-	0.46 - 0.80		AMLEH-20-SP	
AMLE-30-SP	1 / 8	0.85 - 1.55		AMLEH-30-SP	
AMLE-40-SP	1 / 6	1.60 - 3.20		AMLEH-40-SP	
AMLE-50-SP	0.5 / 0.75	3.50 - 6.50		AMLEH-50-SP	
AMLE-60-SP	1 to 2	6.80 - 11.7		AMLEH-60-SP	
AMLE-70-SP	2 to 3	11.0 - 20.0		AMLEH-70-SP	

For flush mounting replace 'E' by 'C' and reduce price by ₹ 50

3- Phase Mini Manual Motor Starter upto 10 HP (Surface Mounting)

HSN CODE : 8536



Cat Code	Recommended HP at 3Ø, 415V	Overload Relay Range (A)	MRP [₹]	Cat Code (with UV Coil)	MRP [₹]
AMLE-10	-	0.23 - 0.47	1345	AMLEN-10	1535
AMLE-20	-	0.46 - 0.80		AMLEN-20	
AMLE-30	0.50 / 0.75	0.85 - 1.55		AMLEN-30	
AMLE-40	1.00 / 1.50	1.60 - 3.20		AMLEN-40	
AMLE-50	3	3.50 - 6.50		AMLEN-50	
AMLE-60	5	6.80 - 11.7		AMLEN-60	
AMLE-70	10	11.0 - 20.0		AMLEN-70	

For flush mounting replace 'E' by 'C' and reduce price by ₹ 50

1-Phase DOL with 2P CPG Contactor & 2P Overload Relay

HSN CODE : 8536



Cat Code	HP / KW at 1Ø, 220V, 50Hz	Overload Relay Range (A)	Contactor Type	Contactor Rating	MRP [₹]
NAAHBW-SP	0.75 / 0.55	3.8 - 6.0	2P CPG	12A	1945
NAHBW-SP	0.75 / 0.55	3.8 - 6.0		16A	1970
NAAJBW-SP	1 / 0.75	6.0 - 9.3		12A	1945
NAJBW-SP	1 / 0.75	6.0 - 9.3		16A	1970
NAKBW-SP	1.5 / 1.10	8.9 - 13.5		20A	2065
NAALBW-SP	2 / 1.5	13.2 - 20.0		25A	2195
NALBW-SP	2 / 1.5	13.2 - 20.0			2235
NAMBW-SP	3 / 2.2	17.4 - 24.0			

Manual Star Delta Starter (with 260-400V AC Coil)

HSN CODE : 8536

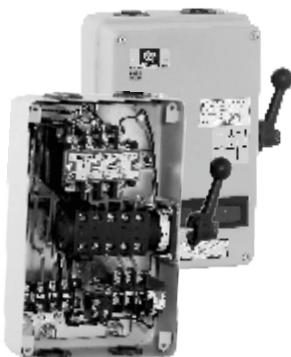

Cat Code	HP at 3Ø, 415V, 50Hz	Overload Relay Range (A)	Contactor Type	Contactor Rating	MRP [₹]
HASSGLEG	3 HP	2.4 - 3.8	C00N	16 A	4510
HASSHLEG	5 HP	3.8 - 6.0			
HASSJLEG	10 HP	6.0 - 9.3	N0N	25 A	5130
HASSKLEG	15 HP	8.9 - 13.5			

HSN CODE : 8538

HASSW15	SPARE SWITCH FOR 15 HP MSD STARTER	2205
---------	------------------------------------	------

Motor Starters (SPS) - Citation.....BCH

Submersible Pump Starters



Three Phase

- Direct on line : upto 24 A relay rating
- Star Delta : upto 135 A (100 HP) relay rating
- Protections :
 - Phase failure
 - Phase imbalance
 - Phase reversal
- Short Circuit Protection Thru MCB : In case of Premium models
- Ammeter and Voltmeter
- On/Off and Trip indications
- Powder coated enclosure with PU gasket ensuring excellent finish and reliability
- Provision for connecting Dry run preventor



On/Trip Indicators



Isolated Terminal blocks for better termination

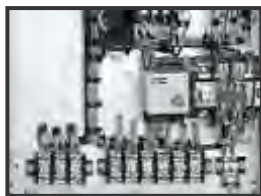

Properly laid down wires, bunched with cable ties Ferrules for ease of identification



Phase indicators (For std & Premium models)

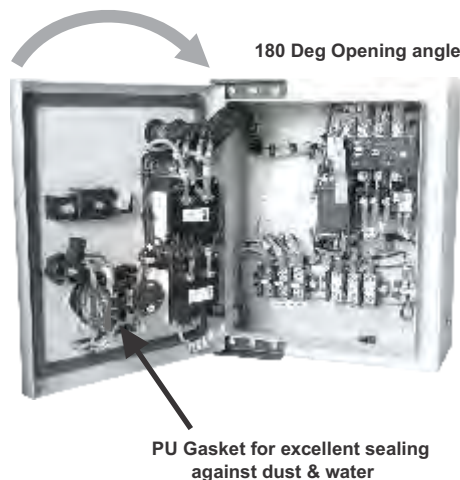

180 Deg Opening angle

PU Gasket for excellent sealing against dust & water



Single Phase

With Mini DOL (up to 11.0 - 20.0 A Relay)

- Economy Model (Without Ammeter)
- Standard Model (With Ammeter)
- Premium Model (With Ammeter & Voltmeter)

With 2 Pole Contactor + 2 Pole Relay (up to 23.0 - 32.0 A Relay)

- Economy Model (With Ammeter)
- Standard Model (With Ammeter & Voltmeter)
- Provision for connecting dry run preventor

Motor Starters - Citation..... BCH



Citation Submersible Pump Starter with 3-Position Selection (with Auto Switch)

DOL

HSN CODE : 8536

Overload Relay Range (A)	Contactor Type	Contactor Rating	DOL			
			Economy (without Short Circuit Protection)		Premium (with Short Circuit Protection)	
			Cat Code	MRP [₹]	Cat Code	MRP [₹]
1.58 - 2.50	C00N	16 A	CPEYNAFN*	7475	--	
2.4 - 3.8	C00N	16 A	CPEYNAGN*	7475		
3.8 - 6.0	C00N	16 A	CPEYNAHN*	7475		
6.0 - 9.3	C00N	16 A	CPEYNAJN*	7475	CPPYNAJN*	10430
8.9 - 13.5	C00N	16 A	CPEYNAKN*	7475	CPPYNAKN*	10430
13.2 - 20.0	C00N	16 A	CPEYNALN*	7865	CPPYNALN*	10955
17.4 - 24.0	N0N	25 A	CPEYNAMN*	8545	CPPYNAMN*	12115
23.0 - 32.0	N01N	32 A	CPEYNA01PN	9720	--	



Citation Submersible Pump Starter with 3-Position Selection (with Auto Switch)

STAR DELTA

HSN CODE : 8536

Overload Relay Range (A)	Contactor Type	Contactor Rating	Star Delta			
			Economy (without Short Circuit Protection)		Premium (with Short Circuit Protection)	
			Cat Code	MRP [₹]	Cat Code	MRP [₹]
3.8 - 6.0	C00N	16 A	CPSDEYHN*	13900	--	
6.0 - 9.3	C00N	16 A	CPSDEYJN*	13900	CPSPYJN*	16740
8.9 - 13.5	C00N	16 A	CPSDEYKN*	13900	CPSPYKN*	16740
13.2 - 20.0	C00N	16 A	CPSDEYLN-C00	14150	--	
13.2 - 20.0	N0N	25 A	CPSDEYLN	15105	CPSPYLN	18045
17.4 - 24.0	N0N	25 A	CPSDEYMN	15500	CPSPYMN	18995
23.0 - 32.0	N01N	32 A	CPSDEY01PN	21705	--	
22.0 - 30.0	N1N	40 A	CPSDEYNN	27040	CPSPYNN	29865
24.4 - 39.0	N1N	40 A	CPSDEYCT1N	28810	CPSPYCT1N	34260
37.6 - 60.0	Citation E	70 A	CPSDEYCT2M	45745	CPSPYCT2M	51495
56.4 - 90.0	Citation E	70 A	CPSDEYECT3M	49775	--	
56.4 - 90.0	Citation M-5	110 A	CPSDEYCT3M	64365	CPSPYCT3M	67875
84.6 - 135.0	Citation M-5	110 A	CPSDEYCT4M	67625	CPSPYCT4M	73535

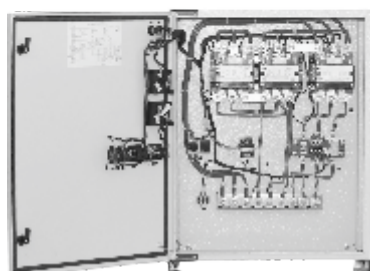

1-Phase SPS With 2P Contactor + Overload Relay (Ammeter + Voltmeter) with 160-220V AC Coil

HSN CODE : 8536

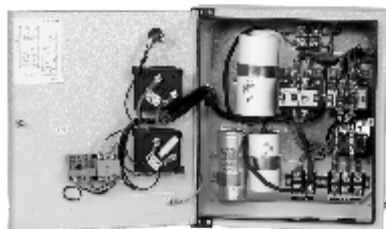

HP at 1Ø, 220V, 50Hz	Overload Relay Range (A)	Contactor Rating	Cat Code	Run Capacitor (mfd)	Start Capacitor (mfd)	MRP [₹]
0.5 / 0.75 HP	3.8 - 6.0	16 Amp	CPNSHBW-SP	25	80/100	4035
			CPNSHBW-SP(RC36)	36	80/100	4035
			CPNSHBW-RC25-SC120	25	100/120	4155
			CPNSHBW-RC30-SC200	30	150/200	4710
1 HP	6.0 - 9.3	16 Amp	CPNSJBW-SP	36	100/120	4160
			CPNSJBW-RC20SC100	20	80/100	4135
			CPNSJBW-RC25SC100	25	80/100	4190
			CPNSJBW-RC50SC100	50	80/100	4315
			CPNSJBW-RC60SC150	60	120/150	4510
			CPNSJBW-RC72SC150	72	120/150	4615
			CPNSJBW-SP(RC30)	30	100/120	4190
			CPNSJBW-SP(RC50)	50	100/120	4315
			CPNSJBW-SP(SC100)	36	80/100	4480
			CPNSJBW-RC36-SC200	36	150/200	4790
			1.5 HP	8.9 - 13.5	16 Amp	CPNSKBW-SP
CPNSKBW-RC30SC120	30	100/120				4460
CPNSKBW-RC36SC120	36	100/120				4480
CPNSKBW-SP(RC36)	36	120/150				4600
CPNSKBW-SP(RC72)	36+36	120/150				4655
CPNSKBW-RC50-SC200	50	150/200				4960
2 HP	13.2 - 20.0	16 Amp	CPNSLBW-SP	72	150/200	4830
			CPNSLBW-SP (2RC36)	36+36	150/200	4900
			CPNSLBW-RC100SC150	100	120/150	4860
			CPNSLBW-RC90SC150	45+45	120/150	4860
			CPNSLBW-SP(SC150)	72	120/150	4960
			CPNSLBW-RC72-SC250	72	200/250	5230
3 HP	17.4 - 24.0	25 Amp	CPNSMBW-SP	100	200/250	5500
	22.0 - 30.0		CPNSMBW-SP(2RC50)	50+50	200/250	5660
			CPNSNBW-SP	100	200/250	5650
	CPNSNBW-SP(2RC50)		50+50	200/250	5810	
5 HP	23.0 - 32.0	40 A & 16 A	CPNSPBW-SP	100+50	200/250	7780
			CPNSPBW-SP(3RC50)	50+50+50	200/250	7975

Suffix "D" in Cat Code for Dry Run Protection panel (only Extra Terminal is provided to connect Dry Run unit)

1-Phase SPS With 2 Pole Contactor + Overload Relay (With Ammeter)

HSN CODE : 8536



Cat Code	HP at 1Ø, 220V, 50Hz	Relay Range (Amp.)	Contactor Rating	Run Capacitor (mfd)	Start Capacitor(mfd)	MRP [₹]
CPNEHBW-SP	0.5 / 0.75 HP	3.8 - 6.0	16 Amp	25	80/100	3715
CPNEJBW-SP	1 HP	6.0 - 9.3	16 Amp	36	100/120	3880
CPNEKBW-SP	1.5 HP	8.9 - 13.5	16 Amp	50	120/150	4260
CPNELBW-SP	2 HP	13.2 - 20.0	16 Amp	36+36	150/200	4505
CPNEMBW-SP	3 HP	17.4 - 24.0	25 Amp	50+50	200/250	5315
CPNEPBW-SP	5 HP	23.0 - 32.0	40 Amp	50+50+50	200/250	7750

Suffix "D" in Cat Code for Dry Run Protection panel (only Extra Terminal is provided to connect Dry Run unit)

1-Phase SPS With Mini Manual DOL Starter (With Ammeter + Voltmeter)

HSN CODE : 8536



Cat Code	HP at 1Ø, 220V, 50Hz	Relay Range (A)	Run Capacitor (mfd)	MRP [₹]
CPPM50-25-SP	0.5 / 0.75 HP	3.5 - 6.5	25	2800
CPPM50-20-SP	0.5 / 0.75 HP	3.5 - 6.5	20	2800
CPPM50H-25-SP	0.5 / 0.75 HP	3.5 - 6.5	25	3185
CPPM60-36-SP	1 HP	6.8 - 11.7	36	2815
CPPM60-25-SP	1 HP	6.8 - 11.7	25	2815
CPPM60H-36-SP	1 HP	6.8 - 11.7	36	3205
CPPM60-50-SP	1.5 HP	6.8 - 11.7	50	2965
CPPM60H-50-SP	1.5 HP	6.8 - 11.7	50	3375
CPPM70-50-SP	2 HP	11.0 - 20.0	50	3010
CPPM70-36-SP	2 HP	11.0 - 20.0	36	3010
CPPM70H-50-SP	2 HP	11.0 - 20.0	50	3425

Motor Starters - Oil Immersed BCH

DOL Starter - 3 Phase

HSN CODE : 8536

Cat. Code	Overload Relay Range (A)	HRC Fuse Rating (EE Type) (max)	MRP[₹]
OISWPGT	2.4 - 3.8	16A	2825
OISWPHT	3.8 - 6.0	20A	2825
OISWPJT	6.0 - 9.3	25A	2825
OISWPKT	8.9 - 13.5	36A	2825
OISWPLT	13.2 - 20.0	50A	2825
OISWPMT	17.4 - 24.0	63A	3115

Note : The last alphabet in the Cat No. indicates coil voltage : N-380-415VAC ; T-220-400VAC ; Y-240-400VAC

Star Delta Starter - Fully Automatic

HSN CODE : 8536

Cat. Code	Overload Relay Range (A)	HRC Fuse Rating (EE Type) (max)	MRP[₹]
OISDAWPJ*	6.0 - 9.3	20A	7980
OISDAWPK*	8.9 - 13.5	32A	7980
OISDAWPL*	13.2 - 20.0	35A	7980
OISDAWPM*	17.4 - 24.0	50A	8530
OISDAWPP*	23.0 - 32.0	63A	8935



Star Delta Starter - Semi Automatic

HSN CODE : 8536

Cat. Code	Overload Relay Range (A)	HRC Fuse Rating (EE Type) (max)	MRP[₹]
OISDSWPJ*	6.0 - 9.3	20A	7160
OISDSWPK*	8.9 - 13.5	32A	7160
OISDSWPL*	13.2 - 20.0	35A	7160
OISDSWPM*	17.4 - 24.0	50A	7695
OISDSWPP*	23.0 - 32.0	63A	8080

Star Delta Starter - Fully Automatic with Auto Unit SPP & 3 Position Auto Manual Switch

HSN CODE : 8536

Cat. Code	Overload Relay Range (A)	HRC Fuse Rating (EE Type) (max)	MRP[₹]
OISDYWPJ*	6.0 - 9.3	20A	9340
OISDYWPK*	8.9 - 13.5	32A	9340
OISDYWPL*	13.2 - 20.0	35A	9340
OISDYWPM*	17.4 - 24.0	50A	9930
OISDYWPP*	23.0 - 32.0	63A	10390

Star Delta Starter - Fully Automatic with Ammeter & Voltmeter

HSN CODE : 8536

Cat. No.	Overload Relay Range (A)	HRC Fuse Rating (EE Type) (max)	MRP[₹]
OISDPYWPL*	13.2 - 20.0	35 A	11480
OISDPYWPM*	17.4 - 24.0	50 A	12080
OISDPYWPP*	23.0 - 32.0	63 A	12630

'N' for 380-415VAC coil & 'Y' for 240-400VAC coil

Spares for Oil Starter

HSN CODE : 8538

Description	Cat No.	MRP[₹]	
Contact kit without coil for DOL - Power & Auxiliary contacts (set of fix contact, moving contact, hex screws, spring washer, spring clip, spring cap, contact spring)	OCK	370	
Power kit without coil for all 3 contactor of star delta starter (fix contact, moving contact, hex screw, spring washer, spring clip, spring cap, contact spring)	Upto L Relay - OCKSD20	920	
	M, P Relay OCKSD30	1060	
Auxiliary Contact Kit set for Star Delta Starter	Upto L Relay - OCKSDAUX20	240	
	M, P Relay OCKSDAUX30	240	
Coil -Main & Delta Contactor	220-400V	OCT	395
	240-400V	OCY	395
	380-415V	OCN	395
Coil -Star Contactor	220-400V	OCT-STAR	270
	240-400V	OCY-STAR	270
	380-415V	OCN-STAR	270
ON-Push Button	OPB-ON	110	
OFF-Push Button	OPB-OFF	110	
Incoming Mounting KIT for 20A	OCTKSD20	120	
Incoming Mounting KIT for 30A	OCTKSD30	170	

Overload Relay for Oil Starter - PIs refer along with all other Overload Relay Page 25

Spares for Starter BCH

Spares for Shakti Starters

HSN CODE : 8538

Cat. No.	Description	MRP[₹]
SHA	Contact Kit	905
SHZ	Coil 190- 400 V	325
SHCC	Contact carrier	155
SHPB	Extended Button Assembly	215
SHCO	Contact for DOL	1950
SHACO	Contact for Star Delta	1950
NCPNYAU*-5S or 5M	Autounit	1105
CPNYAU*-5S or 5M	Autounit (for ASX & OISDY)	1105
CPTB630	Terminal Block 30A 6 way (Auto DOL)	195
CPAMS-3P/ASX	Auto Manual Switch 3 position (Auto DOL)	375

Spares for 3-Phase Submersible Pump Starter

HSN CODE : 8538

Cat. No.	Description	MRP[₹]
NCPYAU* - 5S or 5M	Autounit	1025
CPYAU* - 5S or 5M	Autounit (3 Position SPS)	1025
CPAM25	Ammeter 25A	430
CPAM50	Ammeter 50A	430
CPAM100	Ammeter 100A	445
CPVM500	Voltmeter 500V	430
SPSATG	Electronic Timer (Star Delta)	920
CPTB215	Terminal Block 15A 2 way	50
CPTB360	Terminal Block 60A 3 way	150
CPTB660	Terminal Block 60A 6 way	275
CPTB3100	Terminal Block 100A 3 way	575
CPMB	Mounting Bracket Set	105
CPAMS-2P	Auto Manual Switch 2 position	285
CPAMS-3P	Auto Manual Switch 3 position	305
CPVSS	Voltmeter Selector Switch	310
HEA11GM-PB	Start PB (Green)	150
HEA11RM-PB	Stop PB (Red)	150
HCB10	Aux Block (1 NO)	80
HCB01	Aux Block (1 NC)	80
HFB2PAH	LED-Amber (R-Y-B)	270
HFB2XAM	LED-Amber (Motor Trip)	180
HFB2XRM	LED-RED (415 VAC)	180

Spares for Freedom DOL

HSN CODE : 8538

Cat. No.	Description	MRP[₹]
C320SCB	Start Contact Block	145
CEPBI	Push Button - Green	70
CEPBO	Push Button - Red	70

Spares for Citation M Starters

HSN CODE : 8538

Cat. No.	Description	MRP[₹]
SP100PB3	Start & Stop reset button unit assembly for DOL & SD (upto 150HP)	255
SP100CB	Start actuator Block for DOL	220
SP100CBS	Start actuator Block for SD	220
SP100TB	Terminal Block for Star/ Delta Starters	210
CPTB975	Terminal Block for Star/ Delta Starters (40-50 HP)	670
SPSATG	Electronic Timer (Star Delta)	920
For 250-375 HP SD Starter		
TSFB-R	Push Button (RED)	195
TSFB-G	Push Button (Green)	195
050N1	Aux Contact Block(1NO+1NC)	250

Spares for 1-Phase Submersible Pump Starter

HSN CODE : 8538

Cat. No.	Description	MRP[₹]
ILR-B	"ON" Indication Lamp	65
SPAM-10	Ammeter 10A	430
SPAM-15	Ammeter 15A	430
SPAM-25	Ammeter 25A	430
SPAM-50	Ammeter 50A	430
SPVM-300	Voltmeter 300V	430
CPTB530	Terminal Block 30A 5 way (Mini Version)	105
CPTB530H	Terminal Block 30A 5 way (Contr. Version)	180
CPTB330	Terminal Block 30A 3 way	75
CPTB240	Terminal Block 40A 2 way	110
SPGC	"ON" Push Button GREEN upto 24A relay range	210
SPGB	"ON" Push Button GREEN For 32A relay range	210
SPRC	"OFF" Push Button RED	170
MC305TB4	Add-on Terminal Block for 23-32A relay (outgoing side)	110



Spares for Starter..... BCH



Auto Switch with Single Phase Preventer

HSN CODE : 8536

Cat Code	Product Description	MRP [₹]
ACPAUN-5S	Auto Unit with 5-10 SECONDS DELAY 380-415V	845
ACPAUZ-5S	Auto Unit with 5-10 SECONDS SELAY 230-400V	845
ACPAUZ-5M	Auto Unit with 5 MINUTES DELAY 230-400V	845
ACPAUN-5M	Auto Unit with 5 MINUTES DELAY 380-415V	845

Dual Meter (Combination of Ammeter & Voltmeter)

HSN CODE : 9030



Cat. No.	Product Description	MRP [₹]
CPAM10VM300	COMBINED AM 0-10-60A & VM 0-300V,S-72	620
CPAM15VM300	COMBINED AM 0-15-90A & VM 0-300V,S-72	620
CPAM25VM300	COMBINED AM 0-25-150A & VM 0-300V,S-72	620
CPAM30VM300	COMBINED AM 0-30-180A & VM 0-300V,S-72	620
CPAM50VM300	COMBINED AM 0-50-300A & VM 0-300V,S-72	620
CPAM10VM500	COMBINED AM 0-10-60A & VM 0-500V,S-72 EN	665
CPAM15VM500	COMBINED AM 0-15-90A & VM 0-500V,S-72 EN	620
CPAM30VM500	COMBINED AM 0-30-180A & VM 0-500V,S-72 EN	650
CPAM60VM500	COMBINED AM 0-60-360A & VM 0-500V,S-72 EN	650
CPAM30-60VM500S72	COMBINED AM 0-30-60A & VM 0-500V,S-72	620
CPAM60-120VM500S72	COMBINED AM 0-60-120A & VM 0-500V,S-72	665
CPAM30-60VM500S96	COMBINED AM 0-30-60A & VM 0-500V,S-96	820
CPAM60-120VM500S96	COMBINED AM 0-60-120A & VM 0-500V,S-96	860

COIL VOLTAGE : MASTER TABLE

PRODUCT	110V	160-220V	220-240V	230-360V	260-400V	310-400V	190-400V	230-420V	275-420V	380-415V	415V	440V	550V
	WORKING VOLTAGE BAND	94-121V	136-242V	187-264V	195.5-396V	221-440V	264-440V	161.5-440V	195.5-462V	234-462V	323-456V	353-456V	374-484V
NHD 2P	CPG216	A	BW	H	-	-	-	-	-	N	-	-	-
	CPG225	A	BW	H	-	-	-	-	-	N	-	-	-
	CPG240	A	BW	H	-	-	-	-	-	N	-	-	-
SHAKTI	SHAKTI DOL	-	-	-	-	G	-	Z	ZB	N	-	-	-
	SHAKTI STAR DELTA	-	-	-	-	G	-	Z	-	MB	N	-	-
NHD 4P	C00N	A	-	H	-	G	-	-	-	N	-	C	D
	N0N	A	-	H	-	G	-	-	-	N	-	C	D
	N01N	A	-	H	LV	-	WB	-	-	N	-	-	-
	N1N	A	-	H	-	-	WB	-	-	N	-	C	D
JPG	JPG216/220/225	-	-	H	-	-	-	-	-	N	-	-	-
CITATION	C4 & MC10D	A	-	-	-	-	-	-	-	-	M	C	D
	MC10EN	A	-	-	-	-	-	-	-	-	M	C	D
FREEDOM SERIES	MCE15L TO M5	A	-	-	-	-	-	-	-	-	M	C	D
	MCE15N, Q & S	A	-	-	-	-	-	-	-	-	M	C	D

Enclosure Systems



- Bhartia Boxes IP: 55, IP: 66
- 'BCH-SS' (Stainless Steel) Boxes
- Terminal Boxes IP:55 & IP:66
- Techno - Modular Enclosures
- Smartline - Modular Enclosures
- Semi-Modular Enclosure
- TEOS Plus Enclosure
- Compartmentalized Enclosure (Fixed & Draw-out)
- IT Racks - 19" and ETSI Racks

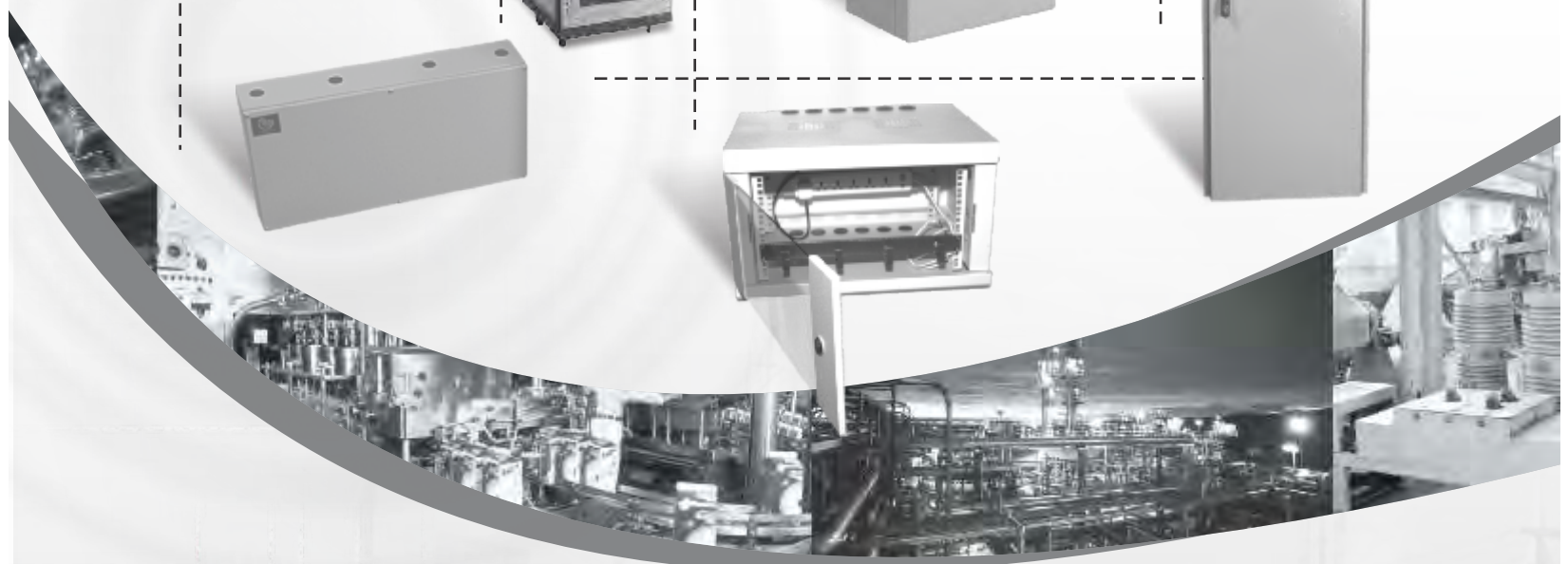
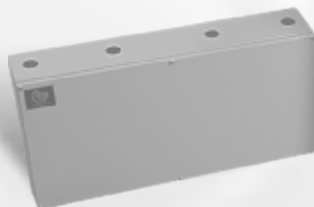

Enclosure Systems

BCH

Bhartia Boxes

HSN Code : 8538



- 51 Different Versions
- Single/Double door versions
- Min. Size : 200 X 200 X 150
- Max Size : 1200 X 1400 X 400
- IP 55/IP66

Double door version

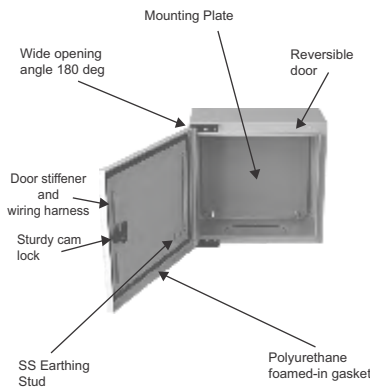

Technical Particulars (BHARTIA BOXES)

- Fabricated from 1.2mm / 1.6mm CRCA sheet steel (Sizes upto BIL-50180 made from 1.2mm CRCA, beyond this using 1.6mm CRCA)
- Foamed-in PU gasket
- Hinged door, interchangeable LHS / RHS, opening angle 180 deg for standard hinge & 120 deg for concealed hinge in bigger sizes.
- IP-55 & 66 Degree of protection
- Cable gland plate 2mm thick provided at bottom
- Cam locking arrangement
- Powder coated to RAL : 7035 structure finish
- Mounting Plate made up of 2.0mm Galvanised steel

Note : Cutout charges will be extra

: Wall mounting bracket set is an additional accessory (for Bhartia Box & Terminal box it is not a part of standard packing)

HSN Code : 8538

Type	Cat. No.	MOQ	List Price [₹]
Set of Wall Mounting bracket (small)	BIL-WM-S	1	115
Set of Wall Mounting bracket (big)	BIL-WM-B	1	135
Set of Wall Mounting bracket Kit 20mm	BIL-WM-H20	1	200

Note :

* Set of wall mounting bracket (small) is suitable for all range of terminal boxes and Bhartia boxes upto size : 400x500x200mm.

* Set of wall mounting bracket (big) is suitable for Bhartia boxes beyond size : 400x500x200mm.

Type	Size (WxHxD) mm	IP-55 Range			IP-66 Range	
		MOQ Nos.	Cat. No.	List Price [₹]	Cat. No.	List Price [₹]
SINGLE DOOR BOX	200x200x150	1	BIL-50000	1950	BIL-60000	2050
SINGLE DOOR BOX	200x300x150	1	BIL-50010	2230	BIL-60010	2280
SINGLE DOOR BOX	250x300x150	1	BIL-50020	2320	BIL-60020	2390
SINGLE DOOR BOX	300x300x150	1	BIL-50030	2500	BIL-60030	2600
SINGLE DOOR BOX	300x300x200	1	BIL-50050	2670	BIL-60050	2820
SINGLE DOOR BOX	300x400x150	1	BIL-50060	2780	BIL-60060	2930
SINGLE DOOR BOX	300x400x200	1	BIL-50080	3120	BIL-60080	3140
SINGLE DOOR BOX	400x300x150	1	BIL-50090	2720	BIL-60090	2890
SINGLE DOOR BOX	400x300x200	1	BIL-50110	3060	BIL-60110	3100
SINGLE DOOR BOX	400x400x150	1	BIL-50120	3120	BIL-60120	3180
SINGLE DOOR BOX	400x400x200	1	BIL-50140	3310	BIL-60140	3410
SINGLE DOOR BOX	400x500x150	1	BIL-50150	3520	BIL-60150	3700
SINGLE DOOR BOX	400x500x200	1	BIL-50170	3730	BIL-60170	3830
SINGLE DOOR BOX	500x500x200	1	BIL-50180	4400		
SINGLE DOOR BOX	400x600x200	1	BIL-50190	4400	BIL-60190	4460
SINGLE DOOR BOX	500x600x200	1	BIL-50210	5050	BIL-60210	5200
SINGLE DOOR BOX	500x700x200	1	BIL-50220	5740		
SINGLE DOOR BOX	500x700x300	1	BIL-50230	6600		
SINGLE DOOR BOX	600x400x200	1	BIL-50240	4480	BIL-60240	4650
SINGLE DOOR BOX	600x400x300	1	BIL-50250	5760		
SINGLE DOOR BOX	600x500x200	1	BIL-50260	5200	BIL-60260	5620
SINGLE DOOR BOX	600x600x200	1	BIL-50270	5410		
SINGLE DOOR BOX	600x600x300	1	BIL-50280	6500		
SINGLE DOOR BOX	600x700x200	1	BIL-50290	6520		
SINGLE DOOR BOX	600x800x200	1	BIL-50300	6540		
SINGLE DOOR BOX	600x800x300	1	BIL-50320	7480		
SINGLE DOOR BOX	600x1000x200	1	BIL-50330	8240		
SINGLE DOOR BOX	600x1000x300	1	BIL-50340	9350		
SINGLE DOOR BOX	800x800x300	1	BIL-50310	8720		
SINGLE DOOR BOX	800x1000x200	1	BIL-50350	9710		
SINGLE DOOR BOX	800x1000x250	1	BIL-50360	9920		
SINGLE DOOR BOX	800x1000x300	1	BIL-50390	10030		
SINGLE DOOR BOX	800x1200x300	1	BIL-50395	12500		
DOUBLE DOOR BOX	1000x800x200	1	BIL-50500	10480		
DOUBLE DOOR BOX	1000x800x300	1	BIL-50520	12020		
DOUBLE DOOR BOX	1000x1000x300	1	BIL-50540	13980		
DOUBLE DOOR BOX	1000x1200x300	1	BIL-50550	16070		
DOUBLE DOOR BOX	1000x1400x300	1	BIL-50560	19220		
DOUBLE DOOR BOX	1200x1400x300	1	BIL-50570	21370		
DOUBLE DOOR BOX	1000x1400x400	1	BIL-50580	20270		
DOUBLE DOOR BOX	1200x1400x400	1	BIL-50590	22310		

MOQ. Minimum order quantity in nos.

Canopy for Bhartia Boxes

HSN Code : 8538

Size (WxHxD) mm	Cat. No.	MOQ Nos.	List Price [₹]	Size (WxHxD) mm	Cat. No.	MOQ Nos.	List Price [₹]
200WX150D	BIL-12-CAN-2015	1	510	600WX200D	BIL-16-CAN-6020	1	980
250WX150D	BIL-12-CAN-2515	1	580	600WX300D	BIL-16-CAN-6030	1	1200
300WX150D	BIL-12-CAN-3015	1	620	800WX300D	BIL-16-CAN-8030	1	1470
300WX200D	BIL-12-CAN-3020	1	680	800WX200D	BIL-16-CAN-8020	1	1190
400WX150D	BIL-12-CAN-4015	1	700	800WX250D	BIL-16-CAN-8025	1	1290
400WX200D	BIL-12-CAN-4020	1	780	1000WX200D	BIL-16-CAN-1020	1	1400
500WX200D	BIL-12-CAN-5020	1	880	1000WX300D	BIL-16-CAN-1030	1	1720
500WX300D	BIL-12-CAN-5030	1	1080				

* List Prices are Ex-works Faridabad. For detail Refer Enclosure Selling Terms & Conditions on page no.110.

***GST to be charged extra**



- Fabricated from 1.2/1.6 mm stainless steel sheet
- Mounting Plate made up of 2.0mm Galvanised steel
- SS grade 304
- Foamed - in PU gasket
- Box upto BIL - 90405020 is made up of 1.2 mm SS & above of 1.6 MM SS.
- 120 deg door open-able concealed hinge door with cam locking arrangement.

'BCH - SS' (Stainless Steel)

HSN Code : 8538

Type	Size (WxHxD) mm	MOQ Nos.	Cat No.	List Price [₹]
SINGLE DOOR BOX	200X300X150	3	BIL-90203015	5140
SINGLE DOOR BOX	300X300X200	3	BIL-90303020	7120
SINGLE DOOR BOX	400X400X200	3	BIL-90404020	9420
SINGLE DOOR BOX	400X500X200	3	BIL-90405020	10490
SINGLE DOOR BOX	400X600X200	3	BIL-90406020	12030
SINGLE DOOR BOX	500X600X200	3	BIL-90506020	15410
SINGLE DOOR BOX	600X600X200	3	BIL-90606020	16480
SINGLE DOOR BOX	600X800X200	3	BIL-90608020	19580
SINGLE DOOR BOX	500X700X300	3	BIL-90507030	19900
SINGLE DOOR BOX	800X800X300	3	BIL-90808030	27390

MOQ - Minimum order quantity in nos.

Note - SS grade 304



- 43 Different Versions
- Min. Size : 150 X 150 X 80
- Max Size : 800 X 400 X 120
- IP 55/IP66

Terminal Boxes

HSN Code : 8538

Box Size (W x H x D)	IP-55 Range			IP-66 Range	
	MOQ	Cat. No.	List Price [₹]	Cat. No.	List Price [₹]
150x150x80	5	BIL-70000	970	BIL-80000	1000
200x150x80	-			BIL-80100	1100
300x150x80	5	BIL-70010	1140	BIL-80010	1270
200x200x80	5	BIL-70020	1090	BIL-80020	1160
300x200x80	5	BIL-70030	1190	BIL-80030	1240
400x200x80	-			BIL-80110	1320
600x200x80	-			BIL-80130	1810
150x150x120	5	BIL-70040	1070	BIL-80040	1140
200x150x120	-			BIL-80150	1180
300x150x120	5	BIL-70050	1270	BIL-80050	1300
200x200x120	5	BIL-70060	1240	BIL-80060	1270
300x200x120	5	BIL-70070	1380	BIL-80070	1410
400x200x120	5	BIL-70080	1550	BIL-80080	1600
300x300x120	5	BIL-70090	1650	BIL-80090	1710
400x150x120	-			BIL-80170	1530
400x300x120	5	BIL-70180	1820	BIL-80180	2050
400x400x120	5	BIL-70190	2150	BIL-80190	2320
500x200x120	5	BIL-70200	1880	BIL-80200	2010
500x300x120	5	BIL-70210	2090	BIL-80210	2210
600x200x120	5	BIL-70220	2100	BIL-80220	2220
600x300x120	5	BIL-70230	2570	BIL-80230	2680
600x400x120	5	BIL-70240	2820	BIL-80240	2920
800x200x120	5	BIL-70250	2970	BIL-80250	3070
800x400x120	5	BIL-70260	3620	BIL-80260	3690

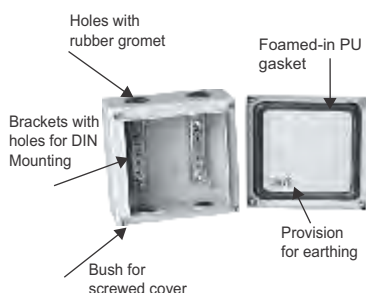

Technical Particulars (TERMINAL BOXES)

- Fabricated from 1.2mm CRCA sheet steel
- Powder coated to shade RAL 7035 Structure finish
- Foamed-in PU gasket
- Provided with screwed cover on top
- IP-55 & 66 Degree of protection
- Brackets provided inside to facilitate DIN rail mounting
- Holes with Gromet provided to facilitate cable entry in IP 55 terminal boxes

Note: Cutout charges will be extra

MOQ-Minimum order quantity in nos.

* List Prices are Ex-works Faridabad. For detail Refer Enclosure Selling Terms & Conditions on page no.110.

***GST to be charged extra**

Enclosure Systems BCH

Techno Modular Enclosures

HSN Code : 8538

Size of Enclosure (W x H x D in mm)	Cat. No.	Enclosure Version*				Plinth		Side Covers (Pair)	
		Ver 001 LP [₹]	Ver 002 LP [₹]	Ver 003 LP [₹]	Ver 004 LP [₹]	Cat. No.	List Price [₹]	Cat. No.	List Price [₹]
600 x 1800 x 400	TME 061804	19260	21450	15300	17660	TPL 061804	1870	TSC 061804	3730
800 x 1800 x 400	TME 081804	23010	25250	17490	20220	TPL 081804	2130	TSC 081804	3730
1000 x 1800 x 400	TME 101804	31670	34130	24560	26860	TPL 101804	2390	TSC 101804	3730
1200 x 1800 x 400	TME 121804	35580	39750	27610	30600	TPL 121804	2620	TSC 121804	3730
600 x 1800 x 500	TME 061805	20120	22150	16320	18350	TPL 061805	2000	TSC 061805	4330
800 x 1800 x 500	TME 081805	23430	26380	18730	20970	TPL 081805	2250	TSC 081805	4330
1000 x 1800 x 500	TME 101805	32530	34990	25630	28250	TPL 101805	2510	TSC 101805	4330
1200 x 1800 x 500	TME 121805	36270	41200	29050	32640	TPL 121805	2730	TSC 121805	4330
800 x 1800 x 600	TME 081806	24980	26220	20330	22260	TPL 081806	2350	TSC 081806	4820
600 x 2000 x 400	TME 062004	20760	23330	15940	18940	TPL 062004	1870	TSC 062004	4010
800 x 2000 x 400	TME 082004	24160	26540	18460	20960	TPL 082004	2130	TSC 082004	4010
1000 x 2000 x 400	TME 102004	34610	36540	26910	28780	TPL 102004	2390	TSC 102004	4010
1200 x 2000 x 400	TME 122004	37180	41090	29750	33710	TPL 122004	2620	TSC 122004	4010
600 x 2000 x 500	TME 062005	22040	23860	18080	20440	TPL 062005	2000	TSC 062005	4710
800 x 2000 x 500	TME 082005	24720	27290	19050	21720	TPL 082005	2250	TSC 082005	4710
1000 x 2000 x 500	TME 102005	34240	38310	27290	30280	TPL 102005	2510	TSC 102005	4710
1200 x 2000 x 500	TME 122005	37440	41200	29430	32640	TPL 122005	2730	TSC 122005	4710
600 x 2000 x 600	TME 062006	22360	24560	19150	21350	TPL 062006	2110	TSC 062006	5240
800 x 2000 x 600	TME 082006	25570	27870	20540	22840	TPL 082006	2350	TSC 082006	5240
1000 x 2000 x 600	TME 102006	34780	39910	27710	32310	TPL 102006	2600	TSC 102006	5240
1200 x 2000 x 600	TME 122006	38180	42320	30920	34880	TPL 122006	2840	TSC 122006	5240
600 x 2000 x 800	TME 062008	23010	24720	19210	21610	TPL 062008	2350	TSC 062008	6740
800 x 2000 x 800	TME 082008	26640	28620	21770	23840	TPL 082008	2600	TSC 082008	6740
1000 x 2000 x 800	TME 102008	38180	40710	29430	32640	TPL 102008	2810	TSC 102008	6740
1200 x 2000 x 800	TME 122008	40130	44510	32960	36270	TPL 122008	3090	TSC 122008	6740
600 x 2200 x 600	TME 062206	25200	27610	20010	23750	TPL 062206	2110	TSC 062206	6070
800 x 2200 x 600	TME 082206	28520	30390	22950	25310	TPL 082206	2350	TSC 082206	6070
1000 x 2200 x 600	TME 102206	39480	42530	32440	35490	TPL 102206	2600	TSC 102206	6070
1200 x 2200 x 600	TME 122206	41030	45800	31890	35630	TPL 122206	2840	TSC 122206	6070
600 x 2200 x 800	TME 062208	27480	29810	21080	24340	TPL 062208	2350	TSC 062208	7890
800 x 2200 x 800	TME 082208	33170	35100	25470	27710	TPL 082208	2600	TSC 082208	7890
1000 x 2200 x 800	TME 102208	42050	45310	34130	36700	TPL 102208	2810	TSC 102208	7890
1200 x 2200 x 800	TME 122208	45480	48040	37240	39750	TPL 122208	3090	TSC 122208	7890

*Baying kit (BIL-14280) Rs. 1260/- is also available for Enclosure Version. For extra accessories, please contact nearest branch office.

MOQ-Minimum order quantity in nos.

Note : Cutout charges will be extra

Freight charges will be extra at actuals

* List Prices are Ex-works Faridabad. For detail Refer Enclosure Selling Terms & Conditions on page no.110.

***GST to be charged extra**

Enclosure Systems BCH

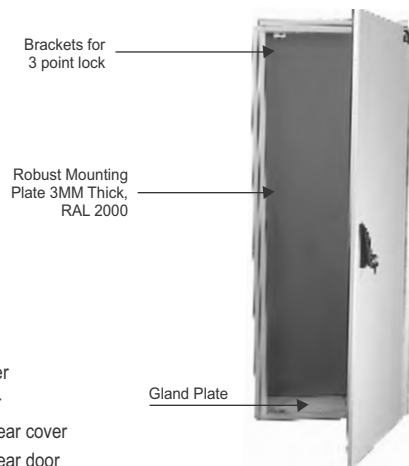

Modular Enclosures

- Enclosures
- Minimum size in mm :
600 x 1800 x 400 (W x H x D)
- Maximum size in mm :
1200 x 2200 x 800 (W x H x D)
- IP 54 / IP 55 degree of protection
- Wide range of accessories

Features

- Completely modular in all the three axis
- Powder coated surface (RAL 7035) for excellent finish and durability
- PU Gasket ensuring higher degree of ingress protection
- 3mm mounting plate as a standard
- Manufactured on CNC Turret punch press for higher precision, finish and repeated accuracy
- Ideal for :
 - Special purpose machines
 - Control panels
 - Drives
 - Starter enclosures
 - Accessories for mounting 19" equipment

Enclosure Versions

- 001 - with mounting plate and rear cover
- 002 - with mounting plate and rear door
- 003 - without mounting plate and with rear cover
- 004 - without mounting plate and with rear door

To Order And Calculate List Price

- (a) Choose Cat. No. and LP of Enclosure version from 001, 002, 003 or 004
- (b) Add Cat. No. and LP of Plinth
- (c) Add Cat. No. and LP of Side Covers pair

General Technical Particulars

- IP54/55 degree of protection
- Fabricated from 2/1.6 mm CRCA/GPSP (frame made up of 2.0mm GPSP, doors & covers made up of 1.6 mm CRCA).
- Fully bolted construction
- Mounting Plate with sliding arrangement - standard & Powder coated to RAL-2000
- Modular Plinth (optional) 100mm high fabricated from CRCA
- Cable entry provision is given from Bottom & made in 3-part construction with Galvanized steel [Unpainted]
- Foamed-in PU gasket
- Powder coated to RAL : 7035 structure finish
- Hinge design allows 120 deg. Door opening
- 3 point lock provided as standard
- Door stiffener with provision of drilling holes for wiring harness.
- Side Covers - Pair : consisting of 1no. LHS and 1no. RHS cover
- To calculate limiting dimension of the enclosure, add 44mm to the width to account for Side Covers,
- 22mm to the height for Top Cover & 44mm to the depth on account of Front and Rear door / cover.

Note : upto 800 mm width single door
1000 mm & 1200 mm width double leaf door

* List Prices are Ex-works Faridabad. For detail Refer Enclosure Selling Terms & Conditions on page no.110.

***GST to be charged extra**

Smartline Modular Enclosure BCH

SmartLine TME

HSN Code : 8538

Size of Enclosure (W x H x D in mm)	Cat. No.	Enclosure Version*				Plinth		Side Covers (Pair)	
		Ver 001 LP [₹]	Ver 002 LP [₹]	Ver 003 LP [₹]	Ver 004 LP [₹]	Cat. No.	List Price [₹]	Cat. No.	List Price [₹]
600 x 1800 x 500	SLE 061805	18730	21190	15190	17490	TPL 061805	2000	SLSC 061805	3910
800 x 1800 x 600	SLE 081806	23330	25040	19150	21290	TPL 081806	2350	SLSC 081806	4330
600 x 2000 x 600	SLE 062006	20870	23330	17870	20010	TPL 062006	2110	SLSC 062006	4730
800 x 2000 x 600	SLE 082006	23910	26480	19210	21710	TPL 082006	2350	SLSC 082006	4730
1200 x 2000 x 600	SLE 122006	36330	40210	29430	33140	TPL122006	2840	SLSC 122006	4730
600 x 2000 x 800	SLE 062008	21350	23490	17980	20280	TPL 062008	2350	SLSC 062008	6080
800 x 2000 x 800	SLE 082008	25310	27180	20280	22630	TPL 082008	2600	SLSC 082008	6080
1200 x 2000 x 800	SLE 122008	37340	42370	31350	34490	TPL 122008	3090	SLSC 122008	6080

Note : Cutout / customization charges will be extra.

*Baying kit (**BIL-14280**) Rs. 1260/- is also available for Enclosure Version. For extra accessories, please contact nearest branch office.

Enclosure Versions

- 001 - With mounting plate and rear cover.
- 002 - With mounting plate and rear door
- 003 - Without mounting plate and with rear cover
- 004 - Without mounting plate and with rear door

To Order and Calculate List Price

(a) Choose Cat. No. and LP of Enclosure version from 001, 002, 003 or 004

(b) Add Cat. No. and LP of Plinth

(c) Add Cat. No. and LP of Side Covers pair

General Technical Particulars

- IP-54 degree of protection
- Fabricated from CRCA/GPSP (frame made up of GPSP, doors & covers made up of CRCA sheet).
- Modular construction
- Mounting plate and cable entry plate made up of Galvanized steel [Unpainted]
- Plinth (optional) 100mm high fabricated from CRCA sheet.
- Cable entry provision is given from Bottom as standard
- Foamed-in PU gasket
- Powder coated to RAL : 7035 structure finish
- Hinge design allows 120 deg. Door opening
- 3 point lock provided as standard
- Door stiffener with provision of drilling holes for wiring harness.
- Side Covers - Pair: consisting of 1no. LHS and 1no. RHS cover
- To calculate limiting dimension of the enclosure, add 44mm to the width to account for Side Covers, 22mm to the height for Top Cover & 44mm to the depth on account of Front and Rear door / cover.

Note : Upto 800 mm width single door. 1000 mm & 1200 mm width double leaf door

* List Prices are Ex-works Faridabad. For detail Refer Enclosure Selling Terms & Conditions on page no.110.

***GST to be charged extra**

Semi-Modular Floor Standing Enclosure..... BCH

HSN Code : 8538

Size of Enclosure (W x H x D in mm)	Cat. No.	List Price [₹]	Plinth		Side Covers (Pair)	
			Cat. No.	List Price [₹]	Cat. No.	List Price [₹]
600X1800X400	FCS 061804	On Request	FCS-PL 061804	On Request	FCS-SC 061804	On Request
600X1800X500	FCS 061805		FCS-PL 061805		FCS-SC 061805	
800X1800X600	FCS 081806		FCS-PL 081806		FCS-SC 081806	
600X2000X600	FCS 062006		FCS-PL 062006		FCS-SC 062006	
800X2000X500	FCS 082005		FCS-PL 082005		FCS-SC 082005	
800X2000X600	FCS 082006		FCS-PL 082006		FCS-SC 082006	
800X2000X800	FCS 082008		FCS-PL 082008		FCS-SC 082008	
1000X2000X600	FCS 102006		FCS-PL 102006		FCS-SC 102006	
1000X2000X800	FCS 102008		FCS-PL 102008		FCS-SC 102008	
1200X2000X500	FCS 122005		FCS-PL 122005		FCS-SC 122005	
1200X2000X600	FCS122006		FCS-PL122006		FCS-SC122006	
1200X2000X800	FCS 122008		FCS-PL 122008		FCS-SC 122008	

Note : Sizes are available in all FOUR version like TME.

Enclosure Versions

- Ver-001 - With mounting plate and rear cover.
- Ver-002 - With mounting plate and rear door
- Ver-003 - Without mounting plate and with rear cover
- Ver-004 - Without mounting plate and with rear door

To Order and Calculate List Price

- (a) Choose Cat. No. and LP of Enclosure version from 001, 002, 003 or 004
- (b) Add Cat. No. and LP of Plinth
- (c) Add Cat. No. and LP of Side Covers pair

Note:

- Cutout / customization charges will be extra.
- Baying Kit (BIL-FCS-14280) LP Rs. 1000/- is also available for Enclosure Versions.
- For extra accessories, Please contact nearest branch office.

Technical Particulars (Semi-Modular Enclosure)

- Unique symmetric front and rear welded frame with modular depth member which resultant fastest assembly and uniformity.
- IP-55 Degree of Protection
- Front and Rear Frame welded & depth members are modular
- Fabricated from 2.0mm/1.6mm CRCA
- Mounting plate made of 2mm thick Galvanized sheet
- Cable entry from bottom of panel as standard
- Powder coated to RAL-7035 Structure finish
- Limiting dimension of the enclosure are same as per sizes given
- Adjustable mounting plate depth wise
- Foamed-in PU gasket
- 3 point lock provided as standard
- Door stiffener with provision of drilling holes for wiring harness.
- Side Covers - Flush Type Side cover Pair consisting of 1no LHS and 1no RHS cover



* List Prices are Ex-works Faridabad. For detail Refer Enclosure Selling Terms & Conditions on page no.110.

***GST to be charged extra**

TEOS Plus Enclosure BCH-TEKPAN

TEOS Plus Enclosure

HSN Code : 8538

Size of Enclosure (W x H x D in mm)	Cat. No.	List Price [₹]
600 x 1800 x 500	TEOS061805	On Request
800 x 1800 x 600	TEOS081806	
600 x 2000 x 600	TEOS062006	
800 x 2000 x 600	TEOS082006	
800 x 2000 x 800	TEOS082008	
1200 x 2000 x 600	TEOS122006	
1000 x 2000 x 800	TEOS102008	
1200 x 2000 x 800	TEOS122008	

Front Door, Rear Door, Rear Cover & Mounting plate shall be supplied as per requirement.



Plinth Corner

HSN Code : 8538

Description	Cat. No.	List Price [₹]
PLINTH CORNER PART H100mm	708.100	On Request

Supply included:- 4 pcs 100mm height corner & mounting accessories.

Plinth Front Cover

HSN Code : 8538

Description	Cat. No.	List Price [₹]	
PLINTH FRONT PROFILE :600	709.160	On Request	
PLINTH FRONT PROFILE :800	709.180		
PLINTH FRONT PROFILE :1000	709.100		
PLINTH FRONT PROFILE :1200	709.120		

Supply included:- 2 pcs 100mm height front cover & mounting accessories.

Plinth Side Cover

HSN Code : 8538

Description	Cat. No.	List Price [₹]	
PLINTH SIDE PROFILE :500	710.150	On Request	
PLINTH SIDE PROFILE :600	710.160		
PLINTH SIDE PROFILE :800	710.180		

Supply included:- 2 pcs 100mm height side cover & mounting accessories.

Side Cover

HSN Code : 8538

Description	Cat. No.	List Price [₹]	
Pair of side cover 500*1800	706.185	On Request	
Pair of side cover 600*1800	706.186		
Pair of side cover 600*2000	706.206		
Pair of side cover 800*1800	706.188		
Pair of side cover 800*2000	706.208		

Supply included:- 2 pcs side cover & mounting accessories

Technical Particulars (TEOS Plus Enclosure)

- Multifold (12-Fold) structure with 100% Modularity.
- IP-65 Degree of Protection.
- SEISMIC Tested for Zone-4 and UL Certified.
- Easy Assembly & Logistic advantages.
- 4-Point lock with Swing Handle.
- Powder coated to RAL: 7035 Structure Finish.
- Limiting dimension of the enclosure are same as per given dimension.

* List Prices are Ex-works Faridabad. For detail Refer Enclosure Selling Terms & Conditions on page no.110.

***GST to be charged extra**

Note :

- Upto 800 mm width single door. 1000 mm & 1200 mm width double leaf door
- Cutout / customization charges will be extra
- For extra accessories, please contact nearest branch office.



Highlights of **BCH** Compartmentalized **MCC / PCC / PMCC** Solution (Fixed & Drawed Type)

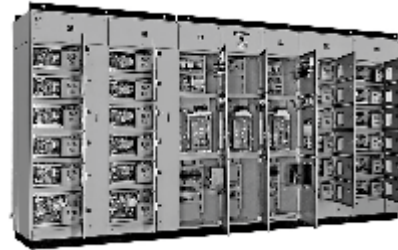

- 100% Modular Structure; can be dispatched in flat pack.
- Flexible compartmentalized - up to From 4.
- IP 54 degree of protection with polyurethane foam gasket.
- Compartment size available from 200mm height & multiplies of 100mm.
- Additional accessories like Cable support, Busbar support, Limit Switch and Lamp brackets are available.
- Adjustable mounting plates (Depth wise at the pitch of 25mm).
- Panel can be expanded in all 3 dimensions and bayed together by using Baying Kit.
- All Structure members (Corner & Cross bar) having M6 extrude hole at 25mm intervals, No need of any Captive hardware.
- Standard Module dimension for Drawout Enclosures.
 - ▷ Single Front :- 900(W) x 2400(H) x 600(D)
 - ▷ Double Front :- 900(W) x 2400(H) x 1200(D)
- Draw-out feeder available from 200mm height (2SU) to 800mm height (8SU).
- Colours :- RAL-7035 (Structure finish) for structure, doors, covers & internal parts RAL-2000 (smooth finish) for Mounting plates, Ral-9000 (Smooth Finish) for Plinth.
- Sheet thickness 2.0mm GPSP for structure, 2.0mm CRCA for Mounting Plate & Mounting rail, 1.6mm CRCA for Doors & Covers, 1.2mm CRCA for Separation plates.

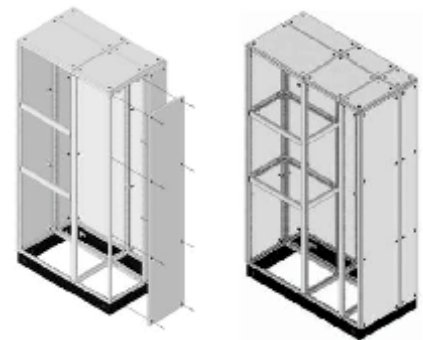

BCH Control Desk

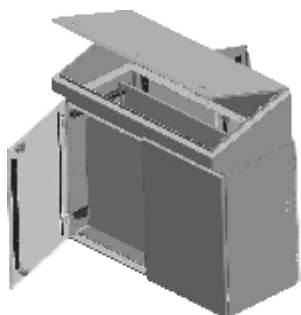

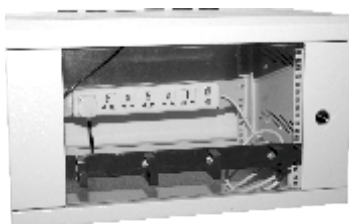

Key Attributes:

- Aesthetic & robust construction
- Mounting Fan /s in top doesn't take usable "U" space.
- Special type of Wallmounting hardware.
- Provision for earthing available in the cabinets.
- Highly corrosion resistant in nature.
- Power coated to shade RAL : 7035 structure finish.

19" Wall Mount Racks

HSN Code : 8538

Dimensions (H x W x D) mm	MOQ Nos.	Cat. No.	List Price [₹]
6UX550X400	1	BIL-W-6-5504	3840
9UX550X400	1	BIL-W-9-5504	4630
6UX550X500	1	BIL-W-6-5505	4240
9UX550X500	1	BIL-W-9-5505	4940
12UX550X500	1	BIL-W-12-5505	5490
15UX550X500	1	BIL-W-15-5505	6460

MOQ-Minimum order quantity in nos.

Standard Configuration: Wallmount cabinet, 2-Pairs of 19" rail.

Notes : Accessories viz. Shelves, Fans, power strips, cable managers captive H/W & wall mounting hardware etc. will be extra as per the accessories list furnished in the price list.
Wall mount racks price do not include freight & will be extra at actuals

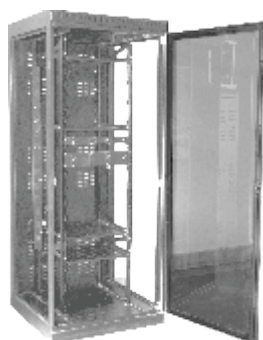

Key Attributes:

- Floor mounting robust design.
- Lockable & removable side panels.
- 2-pairs of adjustable 19" rails.
- Front door with toughened glass & perforation.
- High load bearing capacity.
- Rear vented door.
- Provision for fan mounting in top which doesn't take usable "U" Space.
- Superior cable management facility in extra wide racks.
- 4-integrated vertical cable managers are default design of 800mm wide racks.
- Rear space saving split door with 3-point secure locking in extra wide (800mm) racks.
- Power coated to shade RAL : 7035 structure finish.

19" Networking Racks

HSN Code : 8538

Dimensions (H x W x D) mm	MOQ Nos.	Cat. No.	List Price [₹]
24U X 600 X 600	1	BIL-N-062406	21490
24U X 600 X 800	1	BIL-N-062408	23760
24U X 800 X 600	1	BIL-N-082406	26930
24U X 800 X 800	1	BIL-N-082408	29430
30U X 600 X 600	1	BIL-N-063006	23760
30U X 600 X 800	1	BIL-N-063008	26030
30U X 800 X 600	1	BIL-N-083006	29430
30U X 800 X 800	1	BIL-N-083008	32260
36U X 600 X 600	1	BIL-N-063606	26030
36U X 600 X 800	1	BIL-N-063608	28860
36U X 800 X 600	1	BIL-N-083606	32270
36U X 800 X 800	1	BIL-N-083608	35040
42U X 600 X 600	1	BIL-N-064206	30000
42U X 600 X 800	1	BIL-N-064208	32150
42U X 800 X 600	1	BIL-N-084206	35310
42U X 800 X 800	1	BIL-N-084208	39040
45U X 600 X 600	1	BIL-N-064506	34520
45U X 600 X 800	1	BIL-N-064508	36230
45U X 800 X 600	1	BIL-N-084506	37910
45U X 800 X 800	1	BIL-N-084508	41310

MOQ-Minimum order quantity in nos.

Notes : 1) Networking racks price do not include freight & this will be extra at actuals.

For more details visit : www.bchindia.com/technorack

* List Prices are Ex-works Faridabad. For detail Refer Enclosure Selling Terms & Conditions on page no.110.

***GST to be charged extra**

19" Server Racks

HSN Code : 8538

Key Attributes:

- Floor mounting robust design.
- Lockable & removable side panels.
- 2-pairs of adjustable 19" rails.
- Front door with toughened glass & perforation.
- High load bearing capacity.
- Rear vented door.
- Provision for fan mounting in top which doesn't take usable "U" Space.
- Superior cable management facility in extra wide racks.
- 4-integrated vertical cable managers are default design of 800mm wide racks.
- Rear space saving split door with 3-point secure locking
- locking in extra wide (800mm) racks.
- Power coated to shade RAL : 7035 structure finish.

Dimensions (H x W x D) mm	MOQ Nos.	Cat. No.	List Price [₹]
24U X 600 X 900	1	BIL-S-062409	24280
24U X 600 X 1000	1	BIL-S-062410	25800
30U X 600 X 900	1	BIL-S-063009	27450
30U X 600 X 1000	1	BIL-S-063010	28520
36U X 600 X 900	1	BIL-S-063609	30100
36U X 600 X 1000	1	BIL-S-063610	31700
42U X 600 X 900	1	BIL-S-064209	33840
42U X 600 X 1000	1	BIL-S-064210	35990
42U X 800 X 1000	1	BIL-S-084210	41420
45U X 600 X 900	1	BIL-S-064509	39110
45U X 600 X 1000	1	BIL-S-064510	41380

MOQ - Minimum order quantity in nos.

Notes: Server racks price do not include freight & this will be extra at actuals.

STANDARD CONFIGURATION: Basic frame, Top & bottom, Front Glass door with perforation, Rear vented door, Lockable & detachable side panels, 2-Pairs of 19" rails with depth members.



Key Attributes:

- Includes 1-Pair of 21" rails.
- Integrated side panels.
- Grouting arrangements along with grouting bolts as std. BOM
- Provision for power & detachable Cable entry/exit in top & bottom.
- Power coated to shade RAL : 7035 structure finish.

ETSI Racks

HSN Code : 8538

Dimensions (H x W x D) mm	MOQ Nos.	Cat. No.	List Price [₹]
2200 X 600 x 300	1	ITE-062203	8720
2200 X 600 x 600	1	ITE-062206	14040

MOQ - Minimum order quantity in nos.

Notes: Above ETSI configuration do not include front & rear door and covers.

All other accessories will be extra & will be furnished on request.
The prices mentioned above do not include freight.



Key Attributes:

- 1-Pair of vertical cable manager is default design.
- Surface pretreated and advance powder coated
- Grouting bolts as std. BOM.
- Power coated to shade RAL : 7035 structure finish.

19" Open Racks

HSN Code : 8538

Dimensions (H x W) mm	MOQ Nos.	Cat. No.	List Price [₹]
36U X 600	1	ITE-OF-0636	5670
45U X 600	1	ITE-OF-0645	6680

MOQ - Minimum order quantity in nos.

Notes: 1) Above Open Rack configuration does not include Shelves, Doors and Covers. All other accessories prices will be extra and will be furnished on request.

2) The Prices above do not include Freight and this will be extra at actuals.

For more details, visit : www.bchindia.com/technorack

* List Prices are Ex-works Faridabad. For detail Refer Enclosure Selling Terms & Conditions on page no.110.

***GST to be charged extra**

Accessories for 19" Racks

Fixed Shelf/Stationary Shelf

- Compatible to keep monitor, servers, non 19" Networking & allied equipments.

Key-Board Tray

- Sliding & rotatory type.

Canteliver Shelf

- It can accommodate light weighted networking & allied equipments like modem, routers etc.

Equipment Support Angle

- "L" type angles. Useful to keep non 19" heavy duty equipment in rack mounting position.

Sliding Shelf

- Useful to keep servers, networking & allied equipment which are required to slide out for operational & other purpose.

Fans/Fan Tray

- 220V 90 CFM Capacity. Can be mounted at the top either directly or through Fan housing unit (Fan Tray)

6-Point 5A Hor. Power Strip

- All universal type socket along with on/off switch with fuse & indicator. Internal strips are made up of Berellium copper that has high rate of heat & mechanical tolerance.
- Other 5A or 5/15A Power strips have Indian style (Anchor) Sockets with on/off switch/MCB.

Castors

- 1-Set includes 4Nos. of castors, 2Nos. with foot operated brake & remaining 2 are free.

Levelling Feet

- 1-Set includes 4Nos. of Levelling Feet.

Stability Plate

- It Prevents the racks from toppling while taking out heavy duty servers.

Shelves

HSN Code : 8538

Description	Cat No.	List Price [₹]
Fixed Shelf (600mmD)	BIL-A-FS-L-06	980
Fixed Shelf (800mmD)	BIL-A-FS-L-08	1510
Fixed Shelf (900mmD)	BIL-A-FS-L-09	1680
Fixed Shelf (1000mmD)	BIL-A-FS-L-10	1810
Modem Tray	BIL-A-MD	930
Key board tray (Sliding & Rotatory)	BIL-A-KB-06	2890
Canteliver Shelf (1U)	BIL-A-CS-1	580
Canteliver Shelf (2U)	BIL-A-CS-2	870
Equipment Support Angle (600mmD)	BIL-A-ESA-06	360
Equipment Support Angle (800mmD)	BIL-A-ESA-08	410
Equipment Support Angle (900mmD)	BIL-A-ESA-09	510
Equipment Support Angle (1000mmD)	BIL-A-ESA-10	590
Sliding Shelf (900mmD)	BIL-A-SS-09	2890
Sliding Shelf (1000mmD)	BIL-A-SS-10	3000

Thermal Management

HSN Code : 8538

Description	Cat No.	List Price [₹]
1-Fan (Direct mounted)	BIL-A-SF	980
Fan-tray with 2-Fans (FHU)	BIL-A-FHU-2FANS	2090
Fan-tray with 4-Fans (FHU)	BIL-A-FHU-4FANS	3640

Cable Management

HSN Code : 8538

Description	Cat No.	List Price [₹]
Horizontal Cable Manager (1U)	BIL-A-HCM-1U	230
Horizontal Cable Manager (2U)	BIL-A-HCM-2U	290
Vertical Cable Manager (24U)	BIL-A-VCM-24U	360
Vertical Cable Manager (30U)	BIL-A-VCM-30U	460
Vertical Cable Manager (36U)	BIL-A-VCM-36U	530
Vertical Cable Manager (42U)	BIL-A-VCM-42U	580
Vertical Cable Manager (45U)	BIL-A-VCM-45U	640

Power Management

HSN Code : 8538

Description	Cat No.	List Price [₹]
6-Point 5Amp Horizontal Power Strip (19")	BIL-A-HPS-5AMP	950
5-Point 5/15Amp Horizontal Power Strip (19")	BIL-A-HPS-15AMP	1270
12-Point 5Amp Vertical Power Strip	BIL-A-12VPS-5AMP	1860
10-Point 5/15Amp Vertical Power Strip	BIL-A-10VPS-15AMP	2140
Earth continuity Kit (Earthing Kit)	BIL-A-ECT	720

Stability Management

HSN Code : 8538

Description	Cat No.	List Price [₹]
Castors (1-Set) Heavy Duty	BIL-A-CAS-HD	3490
Castors (1-Set) Light Duty	BIL-A-CAS	2780
Levelling Feet (1-Set)	BIL-A-LF	470
Stability Plate	BIL-A-SP	1750

Miscellaneous

HSN Code : 8538

Description	Cat No.	List Price [₹]
BAYING KIT	BIL-A-BK	340
BLANKING PANEL (1U)	BIL-A-BP-1U	160
BLANKING PANEL (2U)	BIL-A-BP-2U	210
BLANKING PANEL (3U)	BIL-A-BP-3U	270
BLANKING PANEL (4U)	BIL-A-BP-4U	330
BLANKING PANEL (5U)	BIL-A-BP-5U	370
Captive H/w (set of 10)	BIL-A-Captive-M6	160
Wallmounting H/w (set of 4)	BIL-A-wallmounting W	170

Notes : Packing & forwarding will be extra if accessories are ordered separately.

* List Prices are Ex-works Faridabad. For detail Refer Enclosure Selling Terms & Conditions on page no.110.

***GST to be charged extra**

Wires & Cables

- **3-Core Flat Cables for Submersible Pump Applications**
- **Single & Multi Core PVC Flexible Cables**
- **FR & FRLS Cables**



Wires & Cables BCH

BCH Three Core Flat Cables with annealed bare & bunched copper conductor insulated & sheathed with PVC for submersible pump motors for voltage grade 1100 V as per I.S. 694 / 1990 upto 4.0 sqmm, conforming to & marked with I.S. 694 / 2010 upto 35 sqmm.

3 Core Flat Cable PVC Insulated Type CS- 500 Mtrs

HSN Code : 8544

BCH Code	Flat Cable	LP Per 500 Mtrs in [₹]
CS0010BM	1.0 Sqmm x 3 core Flat cable	On Request
CS0015BM	1.5 Sqmm x 3 core Flat cable	
CS0025BM	2.5 Sqmm x 3 core Flat cable	
CS0040BM	4.0 Sqmm x 3 core Flat cable	
CS0060BM	6.0 Sqmm x 3 core Flat cable	
CS0080BM	8.0 Sqmm x 3 core Flat cable	
CS0100BM	10 Sqmm x 3 core Flat cable	
CS0160BM	16 Sqmm x 3 core Flat cable	
CS0250BM	25 Sqmm x 3 core Flat cable	
CS0350BM	35 Sqmm x 3 core Flat cable	

BCH Three Core Flat Cables with annealed bare & bunched copper conductor insulated & thick sheathed with PVC for submersible pump motors for voltage grade 1100 V as per I.S. 694 / 1990 upto 4.0 sqmm, conforming to & marked with I.S. 694 / 2010 upto 16.0 sqmm.

3 Core Flat Cable PVC Insulated Thick Type CFT- 500 Mtrs

HSN Code : 8544

BCH Code	Flat Cable	LP Per 500 Mtrs in [₹]
CFT-03-0010BM	1.0 Sqmm x 3 core Flat cable Thick	On Request
CFT-03-0015BM	1.5 Sqmm x 3 core Flat cable Thick	
CFT-03-0025BM	2.5 Sqmm x 3 core Flat cable Thick	
CFT-03-0040BM	4.0 Sqmm x 3 core Flat cable Thick	
CFT-03-0060BM	6.0 Sqmm x 3 core Flat cable Thick	
CFT-03-0100BM	10 Sqmm x 3 core Flat cable Thick	
CFT-03-0160BM	16 Sqmm x 3 core Flat cable Thick	

BCH Three Core Flat Cables with annealed bare & bunched copper conductor XLPE insulated & PVC sheathed for submersible pump motors of voltage grade 1100 V. suitable for heavy duty usage and areas having frequent supply undervoltage / overvoltage conditions upto 16.0 sqmm.

3 Core Flat Cable XLPE Insulated Type CFTX- 500 Mtrs

HSN Code : 8544

BCH Code	Flat Cable	LP Per 500 Mtrs in [₹]
CFTX-03-0015BM	1.5 Sqmm x 3 core Flat cable XLPE insulated Thick	On Request
CFTX-03-0025BM	2.5 Sqmm x 3 core Flat cable XLPE insulated Thick	
CFTX-03-0040BM	4.0 Sqmm x 3 core Flat cable XLPE insulated Thick	
CFTX-03-0060BM	6.0 Sqmm x 3 core Flat cable XLPE insulated Thick	
CFTX-03-0100BM	10 Sqmm x 3 core Flat cable XLPE insulated Thick	
CFTX-03-0160BM	16 Sqmm x 3 core Flat cable XLPE insulated Thick	

3 Core Flat Cable XLPE Insulated Thick with higher copper conductor Type CFTHX- 500 Mtrs

HSN Code : 8544

BCH Code	Flat Cable	LP Per 500 Mtrs in [₹]
CFTHX-03-0040BM	4.0 Sqmm x 3 core Flat cable XLPE insulated Thick with higher copper conductor	On Request
CFTHX-03-0060BM	6.0 Sqmm x 3 core Flat cable XLPE insulated Thick with higher copper conductor	

Note : For price, please contact our nearest sales office.

Wires & Cables BCH

Single & Multi Core PVC Flexible Cables As Per IS 694: 2010 - With ISI Marking HSN Code : 8544

- Individual conductors drawn from 99.98% bright electrolytic grade copper with more than 100% conductivity
- Special formulation of PVC compounds as per IS 5831:1984 ensures longer and trouble free service life.
- Use only RoHS insulation and sheathing compounds. Ensures cleaner environment and better health.
- Online measurement and monitoring of O.D., core dia and dielectric strength.
- Suitable for -15 to +70°C.

Cat. No.	Conductor Area (nominal)	Safe Current Carrying Capacity 2 wires, Single Phase		LP Per 100 mtrs
		In conduit / Trunking	Unenclosed clipped directly to a surface or on cable tray	
Single Core	(Sq. mm)	(Amp.)	(Amp.)	in [₹]
CR01-0005A-AAA	0.5	4	4.5	On Request
CR01-0008A-AAA	0.75	7	8	
CR01-0010A-AAA	1	11	12	
CR01-0015A-AAA	1.5	13	16	
CR01-0025A-AAA	2.5	18	22	
CR01-0040A-AAA	4	24	29	
CR01-0060A-AAA	6	31	37	
CR01-0100A-AAA	10	42	51	
CR01-0160A-AAA	16	57	68	
CR01-0250A-AAA	25	71	86	
CR01-0350A-AAA	35	91	100	
CR01-0500A-AAA	50	120	145	
HSN Code : 8544				
CR01-0700A-AAA	70	-	214	On Request
CR01-0950A-AAA	95	-	260	
CR01-1200A-AAA	120	-	305	
CR01-1500A-AAA	150	-	355	
CR01-1850A-AAA	185	-	415	
CR01-2400A-AAA	240	-	500	
CR01-3000A-AAA	300	-	560	

Note : Standard packing of 100m, 500m & 1000m available. For price of 500m & 1000m , please contact nearest sales office.

Single Core FR Cables As Per IS 694: 2010 - With ISI Marking HSN Code : 8544

Cat. No.	Conductor Area (nominal)	Safe Current Carrying Capacity 2 wires, Single Phase		LP Per 90 / 100 mtrs
		In conduit / Trunking	Unenclosed clipped directly to a surface or on cable tray	
Single Core	(Sq. mm)	(Amp.)	(Amp.)	in [₹]
CRFR01-0005D-AAA	0.5	4	4.5	
CRFR01-0008D-AAA	0.75	7	8	
CRFR01-0010D-AAA	1	11	12	
CRFR01-0015D-AAA	1.5	13	16	
CRFR01-0025D-AAA	2.5	18	22	
CRFR01-0040D-AAA	4	24	29	
CRFR01-0060D-AAA	6	31	37	
CRFR01-0100D-AAA	10	42	51	
CRFR01-0160A-AAA	16	57	68	
CRFR01-0250A-AAA	25	71	86	
CRFR01-0350A-AAA	35	91	100	
CRFR01-0500A-AAA	50	120	145	

Note: Standard packing of 100m, 90m & 180m available. For prices of 90m & 180m, please contact nearest sales office.
All sizes 16 Sq.mm & above will be in 100 mtrs packing

Single Core FRLS Cables As Per IS 694: 2010 - With ISI Marking HSN Code : 8544

Cat. No.	Conductor Area (nominal)	Safe Current Carrying Capacity 2 wires		LP Per 90 / 100 mtrs
		In conduit / Trunking	Unenclosed clipped directly to a surface or on cable tray	
Single Core	(Sq. mm)	(Amp.)	(Amp.)	in [₹]
CRLS01-0005D-AAA	0.5	4	4.5	
CRLS01-0008D-AAA	0.75	7	8	
CRLS01-0010D-AAA	1	11	12	
CRLS01-0015D-AAA	1.5	13	16	
CRLS01-0025D-AAA	2.5	18	22	
CRLS01-0040D-AAA	4	24	29	
CRLS01-0060D-AAA	6	31	37	
CRLS01-0100D-AAA	10	42	51	
CRLS01-0160A-AAA	16	57	68	
CRLS01-0250A-AAA	25	71	86	
CRLS01-0350A-AAA	35	91	100	
CRLS01-0500A-AAA	50	120	145	

Note: Standard packing of 100m, 90m & 180m available. For prices of 90m & 180m, please contact nearest sales office.
All sizes 16 Sq.mm & above will be in 100 mtrs packing



Wires & Cables BCH

Multi Core PVC Flexible Cables

HSN Code : 8544

Cat. No. 2 Core	Cat. No. 3 Core	Cat. No. 4 Core	Conductor area (Normal)	Current Rating (Amps)
CR02-0005A-AAA-M	CR03-0005A-AAA-M	CR04-0005A-AAA-M	0.5	4
CR02-0008A-AAA-M	CR03-0008A-AAA-M	CR04-0008A-AAA-M	0.75	7
CR02-0010A-AAA-M	CR03-0010A-AAA-M	CR04-0010A-AAA-M	1	12
CR02-0015A-AAA-M	CR03-0015A-AAA-M	CR04-0015A-AAA-M	1.5	15
CR02-0025A-AAA-M	CR03-0025A-AAA-M	CR04-0025A-AAA-M	2.5	20
CR02-0040A-AAA-M	CR03-0040A-AAA-M	CR04-0040A-AAA-M	4	27
CR02-0060A-AAA-M	CR03-0060A-AAA-M	CR04-0060A-AAA-M	6	35
CR02-0100A-AAA-M	CR03-0100A-AAA-M	CR04-0100A-AAA-M	10	46
CR02-0160A-AAA-M	CR03-0160A-AAA-M	CR04-0160A-AAA-M	16	62
CR02-0250A-AAA-M	CR03-0250A-AAA-M	CR04-0250A-AAA-M	25	80
CR02-0350A-AAA-M	CR03-0350A-AAA-M	CR04-0350A-AAA-M	35	102
CR02-0500A-AAA-M	CR03-0500A-AAA-M	CR04-0500A-AAA-M	50	138

Cat. No. 5 Core	Cat. No. 6 Core	Cat. No. 7 Core	Conductor area (Normal)	Current Rating (Amps)
CR05-0005A-AAA-M	CR06-0005A-AAA-M	CR07-0005A-NAA-M	0.5	4
CR05-0008A-AAA-M	CR06-0008A-AAA-M	CR07-0008A-NAA-M	0.75	7
CR05-0010A-AAA-M	CR06-0010A-AAA-M	CR07-0010A-NAA-M	1	12
CR05-0015A-AAA-M	CR06-0015A-AAA-M	CR07-0015A-NAA-M	1.5	15
CR05-0025A-AAA-M	CR06-0025A-AAA-M	CR07-0025A-NAA-M	2.5	20
CR05-0040A-AAA-M	CR06-0040A-AAA-M	CR07-0040A-NAA-M	4	27
CR05-0060A-AAA-M			6	35

Cat. No. 8 Core	Cat. No. 10 Core	Cat. No. 12 Core	Conductor area (Normal)	Current Rating (Amps)
CR08-0005A-NAA-M	CR10-0005A-NAA-M	CR12-0005A-NAA-M	0.5	4
CR08-0008A-NAA-M	CR10-0008A-NAA-M	CR12-0008A-NAA-M	0.75	7
CR08-0010A-NAA-M	CR10-0010A-NAA-M	CR12-0010A-NAA-M	1	12
CR08-0015A-NAA-M	CR10-0015A-NAA-M	CR12-0015A-NAA-M	1.5	15
CR08-0025A-NAA-M	CR10-0025A-NAA-M	CR12-0025A-NAA-M	2.5	20
CR08-0040A-NAA-M	CR10-0040A-NAA-M	CR12-0040A-NAA-M	4	27

Cat. No. 14 Core	Cat. No. 16 Core	Cat. No. 18 Core	Conductor area (Normal)	Current Rating (Amps)
CR14-0005A-NAA-M	CR16-0005A-NAA-M	CR18-0005A-NAA-M	0.5	4
CR14-0008A-NAA-M	CR16-0008A-NAA-M	CR18-0008A-NAA-M	0.75	7
CR14-0010A-NAA-M	CR16-0010A-NAA-M	CR18-0010A-NAA-M	1	12
CR14-0015A-NAA-M	CR16-0015A-NAA-M	CR18-0015A-NAA-M	1.5	15
CR14-0025A-NAA-M	CR16-0025A-NAA-M	CR18-0025A-NAA-M	2.5	20
CR14-0040A-NAA-M	CR16-0040A-NAA-M	CR18-0040A-NAA-M	4	27

Cat. No. 19 Core	Cat. No. 24 Core	Cat. No. 25 Core	Conductor area (Normal)	Current Rating (Amps)
CR19-0005A-NAA-M	CR24-0005A-NAA-M	CR25-0005A-NAA-M	0.5	4
CR19-0008A-NAA-M	CR24-0008A-NAA-M	CR25-0008A-NAA-M	0.75	7
CR19-0010A-NAA-M	CR24-0010A-NAA-M	CR25-0010A-NAA-M	1	12
CR19-0015A-NAA-M	CR24-0015A-NAA-M	CR25-0015A-NAA-M	1.5	15
CR19-0025A-NAA-M	CR24-0025A-NAA-M	CR25-0025A-NAA-M	2.5	20
CR19-0040A-NAA-M	CR24-0040A-NAA-M	CR25-0040A-NAA-M	4	27

Cat. No. 30 Core	Cat. No. 36 Core	Conductor area (Normal)	Current Rating (Amps)
CR30-0005A-NAA-M	CR36-0005A-NAA-M	0.5	4
CR30-0008A-NAA-M	CR36-0008A-NAA-M	0.75	7
CR30-0010A-NAA-M	CR36-0010A-NAA-M	1	12
CR30-0015A-NAA-M	CR36-0015A-NAA-M	1.5	15
CR30-0025A-NAA-M	CR36-0025A-NAA-M	2.5	20
CR30-0040A-NAA-M	CR36-0040A-NAA-M	4	27

The conductor construction given above is indicative only and will be such that all requirements of strand diameter and conductor resistance as per IS 694:1990 and IS 8130:1984 are met.

Sizes 0.5 to 4 Sq. mm from 2 to 5 cores with ISI mark, rest all generally conforming to the IS. Standard packing available in 100 meter coils, longer lengths on drums (500m to 1000m)

Power Factor Control Products

- **LT Power Capacitors - Cylindrical Type**
- **LT Power Capacitors - Box Type**
- **Freedom Series Capacitor Duty Contactor**
- **Super Heavy Duty Box Type Capacitor**
- **Detuned Reactors**
- **Thyristor Switched Module**
- **Automatic Power Factor Controllers (APFC)
& Intelligent Power Factor Controllers (IPFC)**
- **Network Analysers**
- **APFC Panels**



LT Power Capacitors..... BCH

MPP Can type capacitors



MPP Can Type Capacitors(with ISI Mark) (440V)

HSN Code : 8532

KVAR	Normal Duty		Heavy Duty	
	Cat. No.	MRP [₹]	Cat. No.	MRP [₹]
1	BCHMCN001B	270	BCHMCH001B	375
2	BCHMCN002B	540	BCHMCH002B	750
3	BCHMCN003B	810	BCHMCH003B	1125
4	BCHMCN004B	1080	BCHMCH004B	1500
5	BCHMCN005B	1260	BCHMCH005B	1640
7.5	BCHMCN007B	1890	BCHMCH007B	2455
10	BCHMCN010B	2265	BCHMCH010B	3035
12.5	BCHMCN012B	2835	BCHMCH012B	3795
15	BCHMCN015B	3400	BCHMCH015B	4555
20	BCHMCN020B	4535	BCHMCH020B	6075
25	BCHMCN025B	5670	BCHMCH025B	7590

Heavy edge Zn Al Alloy MPP film



.02 - .03 micron metallised layer

MPP Capacitors (IS13340)

MPP capacitors are manufactured using Zn-Al metallized polypropylene film. These modules are provided with pressure interrupter arrangement for safety against bursting due to internal pressure arised due to prolonged high voltage / current. The modules are assembled in aluminium case or CRCA container

MPP Box Type Capacitors(with ISI Mark) (440V)

HSN Code : 8532

KVAR	Normal Duty		Heavy Duty	
	Cat. No.	MRP [₹]	Cat. No.	MRP [₹]
1	BCHMBN001B	265	BCHMBH001B	340
2	BCHMBN002B	530	BCHMBH002B	680
3	BCHMBN003B	795	BCHMBH003B	1025
4	BCHMBN004B	1060	BCHMBH004B	1365
5	BCHMBN005B	1325	BCHMBH005B	1705
7.5	BCHMBN007B	1990	BCHMBH007B	2560
10	BCHMBN010B	2650	BCHMBH010B	3410
12.5	BCHMBN012B	3315	BCHMBH012B	4265
15	BCHMBN015B	3980	BCHMBH015B	5115
20	BCHMBN020B	5305	BCHMBH020B	6820
25	BCHMBN025B	6630	BCHMBH025B	8530



Price of 480V & 525V Capacitors available on request.

LT Power Capacitors..... BCH



APP Box Type Single Layer Capacitors & Super Heavy Duty Box Type Capacitors (with ISI Mark) (440V)

HSN Code : 8532

KVAR	APP Capacitor		SHD Capacitor	
	Cat. No.	MRP [₹]	Cat. No.	MRP [₹]
1	BCHAPS001B	725	BCHSHD001B	1530
2	BCHAPS002B	1445	BCHSHD002B	3060
3	BCHAPS003B	2170	BCHSHD003B	4585
4	BCHAPS004B	2890	-	-
5	BCHAPS005B	3515	BCHSHD005B	6550
7.5	BCHAPS007B	5275	BCHSHD007B	9830
10	BCHAPS010B	6530	BCHSHD010B	13105
12.5	BCHAPS012B	8165	BCHSHD012B	16380
15	BCHAPS015B	9795	BCHSHD015B	19655
20	BCHAPS020B	13060	BCHSHD020B	26210
25	BCHAPS025B	16330	BCHSHD025B	32760

Price of 480V & 525V Capacitors available on request.

Double thick double hazy pp film

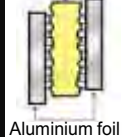

APP Capacitors

Non self healing APP capacitors manufactured using double hazy and double thick polypropylene films between two electrodes of thick aluminium foil have extended foil construction to ensure low watt losses

7% Aluminium wound & Copper wound 440V Detuned Reactors

HSN Code : 8504

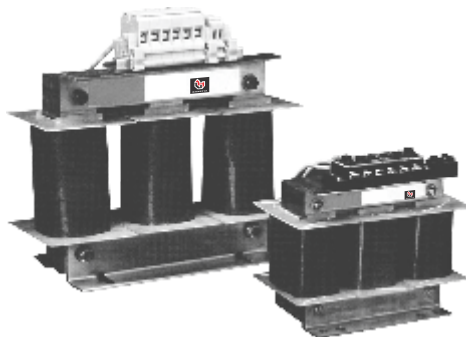

KVAR	Aluminium wound		Copper wound	
	Cat. No.	MRP [₹]	Cat. No.	MRP [₹]
5	BCHRAL005B	7825	BCHRCU005B	12130
10	BCHRAL010B	9430	BCHRCU010B	13965
15	BCHRAL015B	11670	BCHRCU015B	16225
20	BCHRAL020B	14730	BCHRCU020B	19005
25	BCHRAL025B	16235	BCHRCU025B	21735
50	BCHRAL050B	22700	BCHRCU050B	34005
75	BCHRAL075B	32235	BCHRCU075B	48690
100	BCHRAL100B	37005	BCHRCU100B	61280

Freedom series Capacitor duty contactor (AC Control)

HSN Code : 8536

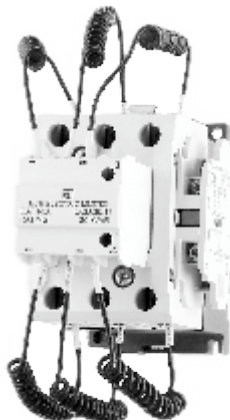

kVAR rating at 415V 3Ph 50Hz	Cat No.	Aux Contacts	MRP [₹]
5	CCD.05.11.■	1NO+1NC	1915
10	CCD.10.11.■	1NO+1NC	2085
15	CCD.15.11.■	1NO+1NC	3045
20	CCD.20.11.■	1NO+1NC	3570
25	CCD.25.11.■	1NO+1NC	4080
30	CCD.30.11.■	1NO+1NC	6720
40	CCD.40.11.■	1NO+1NC	10650
50	CCD.50.21.■	2NO+1NC	10990
60	CCD.60.21.■	2NO+1NC	12560

■ Standard coil voltages are 24, 110, 220/240 & 380/415 V AC, 50 Hz. For voltage codes refer Table on page 24

LT Power Capacitors..... BCH



Thyristor Switched Module with Visual Circuit Indicator HSN Code : 8538



KVAR	Type	Rated Voltage (V)	Cat. No.	MRP [₹]
5	TSM	440	BCHTSM005	31425
10	TSM	440	BCHTSM010	31425
15	TSM	440	BCHTSM015	31425
20	TSM	440	BCHTSM020	35850
25	TSM	440	BCHTSM025	35850
50	TSM	440	BCHTSM050	44710
75	TSM	440	BCHTSM075	74230
100	TSM	440	BCHTSM100	74230

APFC

Intelligent Power Factor Controllers (IPFC)

Steps	Cat. No.	Voltage	Brief description	MRP [₹]
12 STEP - 3φ	RG3-12C	230V	12 Step intelligent PFC	31515
12 STEP - 3φ	RG3-12CS	230V	12 Step intelligent PFC with RS 485 communication	34725
15 STEP - 3φ	RG3-15C	230V	15 Step , Intelligent PFC relay	33035
15 STEP - 3φ	RG3-15CL	230V	15 Step , Intelligent PFC relay with 3 steps for reactor	On request
15 STEP - 3φ	RG3-15CS	230V	15 Step , Intelligent PFC relay with RS485 communication	39965
15 STEP - 3φ	RG3-15CLS	230V	15 Step , Intelligent PFC relay with 3 steps for reactor and RS485 communication	On request

Note : **RG3-8/12/15 and RG3-12/15CS available in 230V only



- 3-Phase / 3CTs
- Connecting Single-Phase & 3-Phase Capacitors
- Compensation of Each Phase
- Measures : A, Cos-Ø, Total W, Total VAR, Total VA, Total KWH, Total KVArh
- Harmonic Measurement (up to 19th)
- THD 1% THD V%
- Programmable THD Protection
- Programmable Discharge Time
- Programmable THD Alarm
- Password Protection for setup
- Overheat Protection (Optional)
- RS-485 Communication (Optional)
- RG-15C - Intelligent relay PFC with smart switching with all 15 steps relay connection
- RG-15C - Intelligent relay PFC with smart switching with all 15 steps relay connection with communication

Automatic Power Factor Controllers (APFC)

Steps	Cat. No.	Voltage	Brief description	MRP [₹]
6 STEP - 1 φ	RG-6T-230-96	230V	PFC (96X96) WITH 6 STEPS , 230 V	12100
6 STEP - 1 φ	RG-6T-415-96	415V	PFC (96X96) WITH 6 STEPS , 415 V	12100
6 STEP - 1 φ	RG-6T-230	230V	PFC (144X144) WITH 6 STEPS, 230 V	12750
6 STEP - 1 φ	RG-6T-415	415V	PFC (144X144) WITH 6 STEPS, 415 V	12750
8 STEP - 1 φ	RG-8T-230	230V	PFC (144X144) WITH 8 STEPS, 230 V	14500
8 STEP - 1 φ	RG-8T-415	415V	PFC (144X144) WITH 8 STEPS, 415 V	14500
8 STEP - 3 φ	RG3-8T-230	230V	PFC 144X144, 8 STEPS, 230V UNABALANCELOAD	19500
12 STEP - 1 φ	RG-12T-230	230V	PFC (144X144) WITH 12 STEPS, 230 V	18155
12 STEP - 1 φ	RG-12T-415	415V	PFC (144X144) WITH 12 STEPS, 415 V	18155
12 STEP - 3 φ	RG3-12T-230	230V	PFC 144X144, 12 STEPS, 230V UNABALANCELOAD	23600

Note : **RG3-8/12/15 and RG3-12/15CS available in 230V only

3Phase Automatic Power Factor Correction (APFC) Panels

Key Features

- Advanced Micro Controller based Power Factor Controller with Self-diagnostic Sensing and Control of Capacitor Bank Stages.
- High performance 'BCH' Cylindrical & Box type Capacitors.
- Capacitor duty Contactors for reliable & trouble free operation.
- Choice of Bhartia-Celduc's world class Solid State Relay (SSR) with TMS² technology as an option.
- Choice of selection of Capacitors as per application & site conditions.
- Thoughtfully designed Panels with provision for louvres & cooling fan for proper ventilation to manage heat load.
- Enclosure with Epoxy based paint shade RAL 7035
- PU Foam Gasketing for sustained Ingress Protection of the Panel.



Five Standard Versions of APFC Panels are available depending upon Switching Sequence, Mode of Control (Automatic & Manual options) & Type of Capacitors (Cylindrical / Box type) used.

VERSION 1 - With BCH MPP Heavy Duty Cylindrical Capacitors & **WITHOUT** Manual option.

VERSION 2 - With BCH MPP Heavy Duty Box Capacitors & **WITHOUT** Manual option.

VERSION 3 - With BCH MPP Heavy Duty Cylindrical Capacitors & **WITH** Manual option.

VERSION 4 - With BCH MPP Heavy Duty Box Capacitors & **WITH** Manual option.

VERSION 5 - With BCH APP Box Type Capacitors & **WITH** Manual option.

(Other tailor made versions on request)

Common Features

CAPACITOR RATING - 40 to 200KVAR in Standard Ratings of 40, 50, 60, 75, 100, 125, 150, 175 & 200 KVAR with suitable banking arrangement.

MOUNTING - Wall Mounting up-to 75KVAR & Floor Mounting above 75 KVAR ratings.

INCOMING - BCH-Resilient 3-P MCCB with Rotary handle.

OUTGOING - TP MCB or HRC fuses with fuse base as standard (BCH-Resilient 3-P MCCB or SDFU and Compartmentalized outgoing feeders can also be provided depending upon size of panel on request).

CONTACTORS - BCH Capacitor Duty Contactors as standard (BCH-Celduc SSR's on request).

R-Y-B INDICATIONS - BCH Flexi-22 LED's.

AMMETER/VOLTMERS - Provided for VERSIONS 3, 4 & 5 only.



For prices contact our nearest sales office.

Motors

ENDURA

Low Voltage AC TEFC Squirrel
Cage Induction Motors

**EFF1
EFF2**

50°C
ambient temperature

Class F

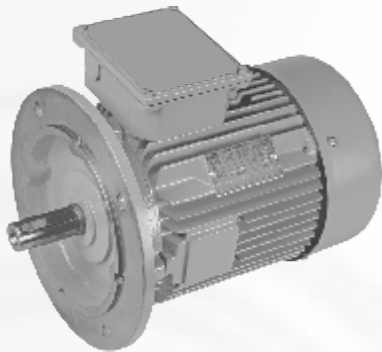

- **0.12 HP to 425 HP**
- **2 to 8 Poles**
- **Vector Plus with forced cooling**
- **Upto 40 intermediate standard ratings**
- **High efficiency, consistent - life long**
- **Low loss for entire life**
- **Inverter duty motor**
- **No deration upto 50° C**
- **Dual coat winding wire as standard feature**
- **6 terminals across the range**
- **Top, LHS, RHS termination flexibility**
- **CE marking**

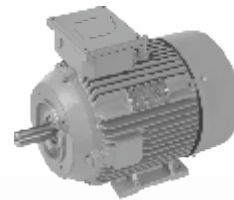
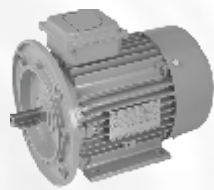

Automation Products

- **AC Drives**
- **Digital DC Drives**
- **Programmable Logic Relays**
- **Soft Starters**
- **e-prox Sensors**
- **Plug-in Relays**
- **Electronic Timers**

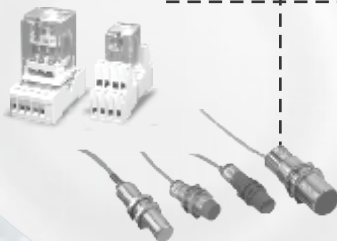

AC Drives BCH

SINUS N Drive



- 0.37~3Kw, Input-1Phase 200-230V AC
- Output - 3 Phase 200-230V AC
- Sensorless vector and V/F control
- Build in PID function

HSN Code - 8504

Rating (Kw)	Drive Series	Product Code	Supply Details	Remark	Current (A)	MRP [₹]
0.37	SINUS N	SINUS N 2S0001XBK2	Input - 1 phase 200 - 230V AC, Output - 3 phase, 230V AC	With EMC	2.5	15600
0.37	SINUS N	SINUS N 2S0001XIK2		W/o EMC	2.5	14700
0.75 - 1.1	SINUS N	SINUS N 2S0002XBK2		With EMC	5	17800
0.75 - 1.1	SINUS N	SINUS N 2S0002XIK2		W/o EMC	5	16700
1.5 - 1.8	SINUS N	SINUS N 2S0003XBK2		With EMC	8	21800
1.5 - 1.8	SINUS N	SINUS N 2S0003XIK2		W/o EMC	8	20000
2.2 - 3	SINUS N	SINUS N 2S0005XBK2		With EMC	12	26500
2.2 - 3	SINUS N	SINUS N 2S0005XIK2		W/o EMC	12	24500

SINUS M Drive



- 0.4~22Kw 380-480V AC, 3 phase
- Sensorless vector and V/F control
- Integrated braking module
- Build in PID function

HSN Code - 8504

Rating (Kw)	Drive Series	Product Code	Supply Details	Remark	Current (A)	MRP [₹]
0.37 - 0.55	SINUS M	SINUS M 4T0001BA2K2	Input - 3 phase 415V AC, Output - 3 phase, 415V AC	With EMC	1.25	24000
0.75 - 0.9	SINUS M	SINUS M 4T0002BA2K2		With EMC	2.50	26000
1.5	SINUS M	SINUS M 4T0003BA2K2		With EMC	4.00	29200
2.2	SINUS M	SINUS M 4T0005BA2K2		With EMC	6.00	31500
3.4	SINUS M	SINUS M 4T0007BA2K2		With EMC	9.00	38700
5.5	SINUS M	SINUS M 4T0011BA2K2		With EMC	12.00	50000
7.5	SINUS M	SINUS M 4T0014BA2K2		With EMC	16.00	58900
11	SINUS M	SINUS M 4T0017BA2K2		With EMC	24.00	103000
15	SINUS M	SINUS M 4T0020BA2K2		With EMC	30.00	118800
18.5	SINUS M	SINUS M 4T0025BA2K2		With EMC	39.00	150500
22	SINUS M	SINUS M 4T0030BA2K2		With EMC	45.00	177000

*SINUS M available in 1 phase to 3 phase version also



AC/DC Drives/Programmable Logic Relay.....BCH

AC Drive



Sinus Penta Drive

- 4.5 - 3000 KW, 3 Phase 380 - 415 VAC
- One Drive - Five functions
 - Vector modulation IFD functionality for general-purpose applications
 - Sensorless vector VTC functionality for high torque-demanding applications
 - Vector FOC functionality with an encoder for accurate torque requirements and a wide speed range
 - Vector SYN functionality for applications with brushless, synchronous motors
 - RGN functionality for the inverter application as an AC/DC converter for the DC supply of multiple drives
- In built Braking chopper upto 132KW rating (S30)
- Serial communication port RS485 – MODBUS RTU Protocol
- Starting Torque upto 240% max
- PID function / second PID function
- Control keypad panel with 12 keys and large back-lit LCD
- Intelligent cooling system
- Encoder feedback
- Full compatibility with teleservice software, "REMOTE DRIVE" on internet
- Compatible with Easy Harmonics, tool for the calculation of Harmonic currents

Digital DC Drives



- From 10A to 4500A (2.4 KW to 2205 KW)
3 Phase 220-690VAC
- 2 & 4 Quadrant digital drive
- Local control from keypad
- 12/7 programmable I/Os
- Predictive control and field boost
- Feedback from dynamo/encoder/armature
- Auto switching in armature F/B against
encoder/tacho feed back failure

Digital DC Drives

HSN Code - 8504

Cat. No.	Armature Current (A)	Field Current (A)
DCREG*.10 POT440V	10	5
DCREG*.20 POT440V	20	5
DCREG*.40 POT440V	40	5
DCREG*.70 POT440V	70	5
DCREG*.100 POT440V	100	5
DCREG*.150 POT440V	150	15
DCREG*.180 POT440V	180	15
DCREG*.250 POT440V	250	15
DCREG*.350 POT440V	350	15
DCREG*.410 POT440V	410	35
DCREG*.500 POT440V	500	35
DCREG*.600 POT440V	600	35
DCREG*.900 POT440V	900	35
DCREG*.1200 POT440V	1200	35

* to complete cat code suffix : 2- for II Quadrant drive 4 - for IV Quadrant drive

Programmable Logic Relay



Super
Relay

Programmable Logic Relay

Compact, Modular, Flexible, Economic and Capable
 Surface mounting & DIN rail mounting
 Controls 82 inputs/outputs including 8 analog inputs.
 Output rating 10Amp for relay and 2Amp for transistor.
 Programming through "SUPER CAD" FBD programming software or LCD programming panel.
 Removable and separately installable LCD display panel.
 Voice module offers auto telephone dialing and pre recorded alarms.
 Industrial wireless remote control module offer 6 wireless remote control input points.
 Three no. extension I/O can be used as distributed I/O up to max. 6 mtrs. in length

* For the prices of above mentioned products please contact our nearest sales office.



ASAC Series Soft- Starter

HSN Code - 8504

- Power supply voltage Range: 200-440VAC
- RS-485 Communication Port
- Compact size & Range 7.5KW - 110KW
- Internal By-pass contactor
- 400% Max allowed overload of nominal current.
- Full Compatibility with teleservice software "Remote Drive" on internet

Protection Functions

- Motor Overload
- Phase loss
- Excess start Time
- Phase Sequence
- Motor thermistor I/P
- Power circuit fault
- Supply Frequency
- Communication Failure

BIL Product Reference	Motor Rating Kw	MRP [₹]	Remark
200 - 440 VAC, IP:20			
ASAC-0/007/4/1	7.5	37500	Without Motor Protection & with Inbuilt Bypass contactor.
ASAC-0/015/4/1	15	38000	
ASAC-0/018/4/1	18.5	38500	
ASAC-0/022/4/1	22	40500	
ASAC-0/030/4/1	30	44500	
ASAC-0/037/4/1	37	53500	
ASAC-0/045/4/1	45	65500	
ASAC-0/055/4/1	55	67200	
ASAC-0/075/4/1	75	101800	
ASAC-0/090/4/1	90	111700	
ASAC-0/110/4/1	110	120500	
200 - 440 VAC, IP:20			
ASAC-1/007/4/1	7.5	52300	With Motor Protections & Inbuilt Bypass contactor.
ASAC-1/015/4/1	15	58300	
ASAC-1/018/4/1	18.5	60000	
ASAC-1/022/4/1	22	63500	
ASAC-1/030/4/1	30	70500	
ASAC-1/037/4/1	37	78700	
ASAC-1/045/4/1	45	96300	
ASAC-1/055/4/1	55	101500	
ASAC-1/075/4/1	75	120500	
ASAC-1/090/4/1	90	158500	
ASAC-1/110/4/1	110	172200	



ASAB Series Soft Starter

- 23A - 1600 A, 200V - 525V AC, 380V-690V AC
- 3 wire and 6 wire connection
- Allowed overload from 300%- 450% of nominal
- Various motor protections built in
- 5/5 programmable I/Os
- Integrated Multimeter

Protection Functions

- Thermal motor protection
- Motor thermistor input (PTC)
- Phase imbalance
- Phase sequence
- Electronic shearpin
- Undercurrent
- Shorted SCR
- ...and many more

Starting Functions

- Constant current start mode
- Current ramp start mode
- Torque control
- Kick start
- Inbuilt bypass contractor upto 220AMP



Medium Voltage Soft- Starter

- Power supply 2300VAC to 15000VAC, Rated current 200A to 600A

* For the prices of above mentioned products please contact our nearest sales office.



Standard Version of Inductive Proximity Switches

HSN Code - 8536



- Sizes from 8mm to 30mm Dia
- Switching Distance from 1.5mm to 15mm
- IP 67, CE Marked
- Sensors with Linear output (4 - 20 mA / 0-10VDC)

General Specifications

- High switching capacity
- 200mA upto 12mm Dia
- 400mA for 18mm and 30mm Dia
- Wide range of outputs
- Voltages AC/DC
- Status LED Indication
- Built in Short circuit protection

Special Versions

- Non Standard sizes from 4mm to 80mm dia
- High temperature sensors upto 125 Deg C
- Square / Slot / Rectangular sensors
- Sensor with shielded cable

Cat. No.	Dia (mm)	Nominal Sn Distance (mm)	Output	Max. Load (mA)	MRP [₹]	Lot Size
Flush Version Nominal Voltage 12-30V DC 3 Wire Output LED Indication Integrated cable 3C/2M						
DINE8SP10	8	1.5	PNP-NO	100	1010	10
DINE8SN10	8	1.5	NPN-NO	100	1010	
DINE12SP10	12	2	PNP-NO	200	800	
DINE12SN10	12	2	NPN-NO	200	800	
DINE18SP10	18	5	PNP-NO	200	850	
DINE18SN10	18	5	NPN-NO	200	850	
DINE30SP10	30	10	PNP-NO	400	1110	
DINE30SN10	30	10	NPN-NO	400	1110	
Non Flush Version Nominal Voltage 12-30V DC 3 Wire Output LED Indication Integrated cable 3C/2M						
DINE8NP10	8	2	PNP-NO	100	1010	10
DINE8NN10	8	2	NPN-NO	100	1010	
DINE12NP10	12	4	PNP-NO	200	800	
DINE12NN10	12	4	NPN-NO	200	800	
DINE18NP10	18	8	PNP-NO	200	850	
DINE18NN10	18	8	NPN-NO	200	850	
DINE30NP10	30	15	PNP-NO	400	1110	
DINE30NN10	30	15	NPN-NO	400	1110	
Flush Version Nominal Voltage 240V AC* 2 Wire Output LED Indication Integrated cable 3C/2M						
DINE12SA10	12	2	NO	200	1000	10
DINE12SA01	12	2	NC	200	1000	
DINE18SA10	18	5	NO	400	1000	
DINE18SA01	18	5	NC	400	1000	
DINE30SA10	30	10	NO	400	1280	
DINE30SA01	30	10	NC	400	1280	
Non Flush Version Nominal Voltage 240V AC* 2 Wire Output LED Indication Integrated cable 3C/2M						
DINE12NA10	12	4	NO	200	1000	10
DINE12NA01	12	4	NC	200	1000	
DINE18NA10	18	8	NO	400	1000	
DINE18NA01	18	8	NC	400	1000	
DINE30NA10	30	15	NO	400	1280	
DINE30NA01	30	15	NC	400	1280	

*110V AC input voltage is also available

ePROX Range

Capacitive Proximity Switches

HSN Code - 8536



- Sizes: 18mm and 30mm dia
- Switching Distance: upto 15mm
- IP 67, CE Compliance

General Specifications

- Max. load current : 400mA
- Wide range of outputs
- Built in Short circuit & polarity reversal protection
- Sensitivity adjustment thru trimmer

Cat. No.	Dia (mm)	Nominal Sn Distance (mm)	Output	Max. Load (mA)	MRP [₹]	Lot Size
Flush Version 12-30V DC 3 Wire Output LED Indication Integrated 3C/2M						
DCAE18SN10	18	1 to 5	NPN-NO	400	2080	10
DCAE18SP10	18	1 to 5	PNP-NO	400	2080	
DCAE30SN10	30	1 to 10	NPN-NO	400	2385	
DCAE30SP10	30	1 to 10	PNP-NO	400	2385	
Non Flush Version 12-30V DC 3 Wire Output LED Indication Integrated 3C/2M						
DCAE18NN10	18	2 to 10	NPN-NO	400	2080	10
DCAE18NP10	18	2 to 10	PNP-NO	400	2080	
DCAE30NN10	30	3 to 15	NPN-NO	400	2385	
DCAE30NP10	30	3 to 15	PNP-NO	400	2385	

Photoelectric Sensors

HSN Code - 8536



- Size : M18 cylindrical
- Mode : diffuse, retro and thru beam
- LED indication
- Sensing distance 20cm to 5mtr.

Special Versions

- Sensors in Rectangular housing

Cat. No.	Dia (mm)	Nominal Sn Distance (mm)	Output	Max. Load (mA)	MRP [₹]	Lot Size
Nominal Voltage : 12-30V DC Diffuse Scan DC 4-W Output LED Indication Prewired with 2 m Cable						
DPHE18D2N11	18	200	NPN-NO+NC	200	3160	10
DPHE18D2P11	18	200	PNP-NO+NC	200	3160	
Nominal Voltage : 12-30V DC Retro Reflective DC 4-W Output LED Indication Prewired with 2 m Cable						
DPHE18RRN11	18	1000	NPN-NO+NC	200	3170	10
DPHE18RRP11	18	1000	PNP-NO+NC	200	3170	
Nominal Voltage : 12-30V DC Through Beam DC 4-W Output LED Indication Prewired with 2 m Cable						
DPHE18TBRP11	18	5000	PNP-NO+NC	200	3800	10
DPHE18TBRN11	18	5000	NPN-NO+NC	200	3800	

Note :

- Prices for Thru Beam, Photo Sensors are inclusive of emitters & receivers.
- Prices for Retro Reflective Sensors are inclusive of reflectors.



Standard Version of Inductive Proximity Switches

HSN Code - 8536

Cat. No.	Dia (mm)	Nominal Sn Distance (mm)	Output	Connector Size	MRP [₹]	Lot Size
Flush Version Nominal Voltage 12-30V DC 3 Wire Output LED Indication, 200 mA Load upto 12mm & 400 mA for 18 mm						
DINE8SP10K	8	1.5	PNP-NO	M8 Connector	1040	10
DINE8SN10K	8	1.5	NPN-NO	M8 Connector	1040	
DINE12SP10K	12	2	PNP-NO	M12 Connector	1040	
DINE12SN10K	12	2	NPN-NO	M12 Connector	1040	
DINE18SP10K	18	5	PNP-NO	M12 Connector	1040	
DINE18SN10K	18	5	NPN-NO	M12 Connector	1040	
DINE30SP10K	30	10	PNP-NO	M12 Connector	1175	
DINE30SN10K	30	10	NPN-NO	M12 Connector	1175	
Non Flush Version Nominal Voltage 12-30V DC 3 Wire Output LED Indication						
DINE8NP10K	8	2	PNP-NO	M8 Connector	1040	10
DINE8NN10K	8	2	NPN-NO	M8 Connector	1040	
DINE12NP10K	12	4	PNP-NO	M12 Connector	1065	
DINE12NN10K	12	4	NPN-NO	M12 Connector	1065	
DINE18NP10K	18	8	PNP-NO	M12 Connector	1040	
DINE18NN10K	18	8	NPN-NO	M12 Connector	1040	
DINE30NP10K	30	15	PNP-NO	M12 Connector	1175	
DINE30NN10K	30	15	NPN-NO	M12 Connector	1175	
Cat. No.	Description Female Connectors				MRP [₹]	
DM8K3	M8 3-Wire straight connector w/o LED & 2 m cable				800	10
DM8K390LE	M8 3-Wire "L" type connector with LED & 2 m cable				800	
DM12K4	M12 4-Wire straight connector w/o LED & 2 m cable				540	
DM12K490	M12 4-Wire "L" type connector w/o LED & 2 m cable				790	
DM12K490LE	M12 4-Wire "L" type connector with LED & 2 m cable				840	
Linear Output Inductive Proximity Sensor - Nominal Voltage 24V DC, 2m Integrated Cable						
DINE18LIN	18	5	0 - 10V	2 m long PVC Cable	1785	10
DINE18LINMA	18	5	4 - 20 mA		1785	

Standard Version DC 2 Wire Proximity Switches

HSN Code - 8536

Cat. No.	Dia (mm)	Nominal Sensing Distance (mm)	Output	Max. Load (mA)	MRP [₹]	Lot Size
Flush Version Nominal Voltage 24V DC 2 Wire Output LED Indication, Integrated 3C/2m long PVC Cable 65mm long tubular Metallic Housing						
DINE8SD10	8	1.5	NO	200	1240	10
DINE12SD10	12	2	NO	200	850	
DINE18SD10	18	5	NO	400	880	
DINE30SD10	30	10	NO	400	1145	
Non Flush Version, Nominal Voltage 12-30V DC 2 Wire Output LED Indication, Integrated 3C/2m long PVC Cable 65mm long tubular Metallic Housing						
DINE8ND10	8	2	NO	200	1240	10
DINE12ND10	12	4	NO	200	850	
DINE18ND10	18	8	NO	400	880	
DINE30ND10	30	15	NO	400	1145	

Note : for NC output, replace suffix 10 by 01



Short Housing Inductive Proximity Switch-45mm length

HSN Code - 8536

Cat. No.	Dia (mm)	Nominal Sensing Distance (mm)	Output	Max. Load (mA)	MRP [₹]	Lot Size
Flush Version Nominal Voltage 12-30V DC, 3 Wire Output, LED Indication, Integrated 3C/2m long PVC Cable						
45mm long tubular Metallic Housing						
DINE8SP10S	8	1.5	PNP-NO	200	1280	10
DINE8SN10S	8	1.5	NPN-NO	200	1280	
DINE12SP10S	12	2	PNP-NO	200	860	
DINE12SN10S	12	2	NPN-NO	200	860	
DINE18SP10S	18	5	PNP-NO	400	895	
DINE18SN10S	18	5	NPN-NO	400	895	
Non Flush Version, Nominal Voltage 12-30V DC, 3 Wire Output, LED Indication, Integrated 3C/2m long PVC Cable						
45mm long tubular Metallic Housing						
DINE8NP10S	8	2	PNP-NO	200	1280	10
DINE8NN10S	8	2	NPN-NO	200	1280	
DINE12NP10S	12	4	PNP-NO	200	860	
DINE12NN10S	12	4	NPN-NO	200	860	
DINE18NP10S	18	8	PNP-NO	400	895	
DINE18NN10S	18	8	NPN-NO	400	895	

Square / Rectangular Proximity Switch

HSN Code - 8536

Cat. No.*	Size (mm)	Nominal Sensing Distance (mm)	Output	Max. Load (mA)	MRP [₹]	Lot Size
Flush Version, Nominal Voltage 12-30V DC, 3 Wire Output, LED Indication, Integrated 3C/2m long PVC Cable, Plastic Housing						
DINE1717SP10P	17x17x30	5	PNP-NO	200	890	10
DINE2020SN10P	20x20x38	5	NPN-NO	200	900	
DINE5025SP10P	50x25x10	5	PNP-NO	200	935	
DINE1717SN10P	17x17x30	5	NPN-NO	200	890	
DINE2020SP10P	20x20x38	5	PNP-NO	200	900	
DINE5025SN10P	50x25x10	5	NPN-NO	200	935	

High Ambient Temperature (up to 125°C) Proximity Switch

HSN Code - 8536

Cat. No.*	Size (mm)	Nominal Sensing Distance (mm)	Output	Max. Load (mA)	MRP [₹]	Lot Size
Flush/Non Flush Version, Nominal Voltage 230V AC, 2 Wire Output, LED Indication, Integrated 3C/2m long Cable, SS Housing						
DINE30SA10HT **	30	4	NO	200	3445	10
DINE30NA10HT **	30	6	NO	200	3420	
DINE18SA10HT **	18	2	NO	200	3270	
DINE18NA10HT **	18	3	NO	200	3270	

* For NC Output, Replace Suffix 10 by 01

** For 110V AC input, Replace A by 2A

Plug in Relays-ASP Series BCH

Plug In Relays - Universal (ASPU)

HSN Code - 8536



- Type ASPU
- 10 Amp (Res) Contact rating
- 2 Change over / 3 Change over

Coil Voltage	Without latch / Manual Testing		With latch / Manual Testing		Contacts	Lot Size
	Cat. No.	MRP [₹]	Cat. No.	MRP [₹]		
8 Pin - contact rating 10A (Res.) at 24V DC/240V AC, LED Indication						
6V DC	ASPU206DLE	325	-	-	2 C/O	10
12V DC	ASPU212DLE	330	ASPU212DLET	480		
24V DC	ASPU224DLE	325	ASPU224DLET	480		
48V DC	ASPU248DLE	360	-	-		
110V DC	ASPU2110DLE	360	ASPU2110DLET	500		
6V AC	ASPU206ALE	355	-	-		
12V AC	ASPU212ALE	360	ASPU212ALET	525		
24V AC	ASPU224ALE	385	ASPU224ALET	515		
110V AC	ASPU2110ALE	380	ASPU2110ALET	510		
240V AC	ASPU2240ALE	420	ASPU2240ALET	570		
11 Pin - contact rating 10A (Res.) at 24V DC/240V AC, LED Indication						
12V DC	ASPU312DLE	400	ASPU312DLET	500	3 C/O	10
24V DC	ASPU324DLE	390	ASPU324DLET	510		
48V DC	ASPU348DLE	415	-	-		
110V DC	ASPU3110DLE	425	ASPU3110DLET	560		
12V AC	ASPU312ALE	440	ASPU312ALET	545		
24V AC	ASPU324ALE	445	ASPU324ALET	570		
110V AC	ASPU3110ALE	440	ASPU3110ALET	580		
240V AC	ASPU3240ALE	470	ASPU3240ALET	610		

Plug In Relays - Universal (ASPS)

HSN Code - 8536



- Type ASPS
- 5 Amp (Res) Contact rating
- 2 Change over / 3 Change over

Coil Voltage	Cat. No.	Contacts	MRP [₹]	Lot Size
8 Pin - contact rating 5A (Res.) at 24V DC/240V AC, LED Indication				
6V DC	ASPS206DLE	2 C/O	310	10
12V DC	ASPS212DLE		290	
24V DC	ASPS224DLE		290	
48V DC	ASPS248DLE		320	
110V DC	ASPS2110DLE		335	
6V AC	ASPS206ALE		320	
12V AC	ASPS212ALE		315	
24V AC	ASPS224ALE		320	
110V AC	ASPS2110ALE		315	
240V AC	ASPS2240ALE		360	
11 Pin - contact rating 5A (Res.) at 24V DC/240V AC, LED Indication				
12V DC	ASPS312DLE	3 C/O	360	10
24V DC	ASPS324DLE		360	
48V DC	ASPS348DLE		430	
110V DC	ASPS3110DLE		410	
24V AC	ASPS324ALE		350	
110V AC	ASPS3110ALE		360	
240V AC	ASPS3240ALE		405	

Sockets for ASPU / ASPS Plug in Relay

HSN Code - 8538

Cat. No.	Type	MRP [₹]	Lot Size
10A, 240V AC, Screw Terminals, 35mm DIN Rail Mounting			
ASSU11	SOCKET 11 PIN FOR ASPS/ASPU Relay	170	10
ASSU8	SOCKET 8 PIN FOR ASPS/ASPU Relay	125	

* For price of other coil voltage, please contact our nearest sales office.

Plug in Relays-ASP Series BCH

Plug In Relays - Miniature (ASPM)

HSN Code - 8536



- Type ASPM
- 5 Amp (Res) Contact rating
- 2 Change over / 4 Change over

Coil Voltage	Cat. No.	Contacts	MRP [₹]	Lot Size
14 Pin - contact rating 5A (Res.) at 24V DC/240V AC, LED Indication				
12V DC	ASPM412DLE	4 C/O	255	20
24V DC	ASPM424DLE		255	
48V DC	ASPM448DLE		260	
110V DC	ASPM4110DLE		260	
24V AC	ASPM424ALE		280	
110V AC	ASPM4110ALE		290	
240V AC	ASPM4240ALE		290	
8 Pin - contact rating 5A (Res.) at 24V DC/240V AC, LED Indication				
12V DC	ASPM212DLE	2 C/O	225	20
24V DC	ASPM224DLE		225	
48V DC	ASPM248DLE		255	
110V DC	ASPM2110DLE		255	
24V AC	ASPM224ALE		255	
110V AC	ASPM2110ALE		255	
240V AC	ASPM2240ALE		255	

Sockets - for ASPM Plug in Relay

HSN Code - 8538

Cat. No.	Type	MRP [₹]	Lot Size
5A, 240V AC, Screw Terminals, 35mm DIN Rail Mounting			
ASSM14	SOCKET 14 PIN FOR ASPM Relay	200	20
ASSM8	SOCKET 8 PIN FOR ASPM Relay	135	

* For price of other coil voltage, please contact our nearest sales office.

Universal Relays



- Type ARPU
- 10 Amp (Res) Contact rating
- 2 Change over / 3 Change over
- Silver Nickle Contacts
- Built in Mechanical Indicator/ Latching facility
- Wide Coil Voltages
- With and without LED
- 8 Pin / 11 Pin Socket



Socket & Clamp (ARPU)

35 mm DIN rail mounting Rating : 10A, 250V



Plug In Relays - Universal (ARPU)

HSN Code - 8536

Coil Voltage	Without LED Indication		With LED Indication		Contacts	Lot Size
	Cat. No.	MRP [₹]	Cat. No.	MRP [₹]		
8 Pin, Contact rating = 10A (Res.) at 24V DC/250V AC; Mechanical indicator with manual testing/latching lever						
12 V DC	ARPU212D	670	ARPU212DLE	935	2 C/O	10
24V DC	ARPU224D	750	ARPU224DLE	910		
48V DC	ARPU248D	725	ARPU248DLE	725		
110V DC	ARPU2110D	700	ARPU2110DLE	700		
24VAC	ARPU224A	650	ARPU224ALE	650		
48VAC	ARPU248A	600	ARPU248ALE	700		
110V AC	ARPU2110A	700	ARPU2110ALE	700		
230V AC	ARPU2230A	755	ARPU2230ALE	925		
11 Pin, Contact rating = 10A (Res.) at 24V DC/250V AC; Mechanical indicator with manual testing/latching lever						
12 V DC	ARPU312D	725	ARPU312DLE	725	3 C/O	10
24V DC	ARPU324D	870	ARPU324DLE	870		
48V DC	ARPU348D	740	ARPU348DLE	770		
110V DC	ARPU3110D	755	ARPU3110DLE	755		
24VAC	ARPU324A	740	ARPU324ALE	745		
48VAC	ARPU348A	740	ARPU348ALE	740		
110V AC	ARPU3110A	675	ARPU3110ALE	945		
230V AC	ARPU3230A	835	ARPU3230ALE	975		

Sockets for ARPU Plug in Relay

Cat. No.	Type	MRP [₹]	Lot Size
10A, 250V AC, Screw Terminals, 35mm DIN Rail Mounting			
ARSU11	11 Pin Socket	345	10
ARSU8	8 Pin Socket	320	
ARPUCL	Holding Clamp	35	

Plug in Relays-ARP Series/Timer..... BCH

Miniature Plug in Relays



- Type ARPM 2/4
- 12/6 Amp. (Res.) Contact rating
- 2 Change over / 4 Change over
- Silver Nickle Contacts
- Built in Mechanical Indicator/Latching facility
- Wide Coil Voltages
- 8 Pin / 14 Pin Socket

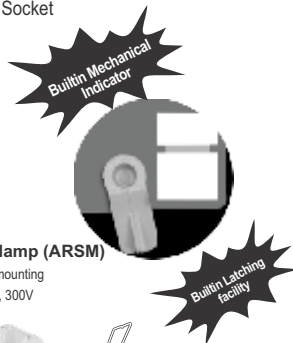

Socket & Clamp (ARSM)
35 mm DIN rail mounting
Rating : 6A, 12A, 300V



On Delay



- Fixed Voltage, Fixed Time
- Wide range of input supply - 220VAC; 110VAC; 24V AC/DC
- Large calibrated dial for easy and accurate time setting
- LED indications for Input supply and Output status
- Surface mounting & DIN rail mounting
- 1 changeover relay output (SPDT)
- All Purpose On Delay timer

Multi Function



- 4 Functions - On delay, Interval, Off delay, Single Shot
- Multi Time Range - Sec / Min / Hr
- Universal Voltage - 24 V- 230VAC/DC
- Large calibrated dial for easy and accurate time setting
- Compact Design
- LED indications for Input supply and Output status
- Surface mounting & DIN rail mounting
- 1 changeover relay output (SPDT)
- All Purpose Timer

Plug in Relays - Miniature (ARPM)

HSN Code - 8536

Coil Voltage	Without LED Indication		With LED Indication		Contacts	Lot Size
	Cat. No.	MRP [₹]	Cat. No.	MRP [₹]		
14 Pin, Contact rating = 6A (Res.) at 24V DC/250VAC; Mechanical indicator with manual testing/latching lever						
12 V DC	ARPM412D	310	ARPM412DLE	425	4 C/O	10
24V DC	ARPM424D	300	ARPM424DLE	345		
48V DC	ARPM448D	360	ARPM448DLE	390		
110V DC	ARPM4110D	465	ARPM4110DLE	465		
24V AC	ARPM424A	330	ARPM424ALE	380		
48V AC	ARPM448A	350	ARPM448ALE	400		
110V AC	ARPM4110A	325	ARPM4110ALE	360		
230V AC	ARPM4230A	340	ARPM4230ALE	380		
8 Pin, Contact rating = 12A (Res.) at 24V DC/250VAC; Mechanical indicator with manual testing/latching lever						
12 V DC	ARPM212D	430	ARPM212DLE	450	2 C/O	10
24V DC	ARPM224D	320	ARPM224DLE	390		
48V DC	ARPM248D	450	ARPM248DLE	490		
110V DC	ARPM2110D	470	ARPM2110DLE	470		
24V AC	ARPM224A	305	ARPM224ALE	455		
48V AC	ARPM248A	450	ARPM248ALE	480		
110V AC	ARPM2110A	365	ARPM2110ALE	380		
230V AC	ARPM2230A	345	ARPM2230ALE	405		

Sockets for ARPM Plug in Relay

Cat. No.	Type	MRP [₹]	Lot Size
Screw Terminals, 35mm DIN Rail Mounting			
ARSM14	14 Pin Socket	275	10
ARSM8	8 Pin Socket	210	
ARPMCL	Holding Clamp	35	

IBT Electronic Timer

Fixed Voltage; Fixed Time Range - IBTA

HSN Code - 9107

Cat No.	Time Range	Function	MRP [₹]
IBT00-0-	0.6-6/3-30/6-60/18-180 Sec	On Delay	900

- Voltage Code
- Timing Range for IBTA On Delay Timer

Voltage Codes

Voltage	Voltage Code
240V AC	1
110V AC	2
24V AC/DC	3
12V DC	4

Timing Code for IBTA On Delay Timer

Time Range	Code
0.6 - 6 Sec.	1
3 - 30 Sec.	2
6 - 60 Sec.	3
18 - 180 Sec.	4

Universal Voltage, Multi Time, Multi Function - IBTMU

HSN Code - 9107

Cat No.	Time Range	Function	Voltage	MRP [₹]
IBT04500	0.1S - 10 Hr.	On Delay, Off Delay, Interval, Single Shot	24-240V AC/DC	1740



- On Delay
- Off Delay
- Cyclic
- Multifunction
- Star Delta
- Special version for Compressor application
- AC / DC Supply
- Widest timing range from 0.1 sec to 10 Hours in Single Unit
- Calibrated time scale for easy time setting
- DIN rail mounting
- Excellent repeat accuracy

Electronic Timers

HSN Code - 9107

Description	Cat.No.	MRP [₹]
Timer Encapsulated on delay Timer Type SAS-P (Solid State output) Voltages : 240V AC, 110V AC, 48V AC/DC, 24V AC/DC Time Range : 1 sec. or 0.1-10 Sec. or 1-100 Sec., or 3-300 Sec.	SST00-0-	925
Encapsulated on delay timer type SAS-CB (Solid State output) (Compressor/Heat pump) Voltages : 240V AC, 110V AC, 48V AC/DC, 24V AC/DC Time Range : 180 Sec. fixed	SST02-00	925
Chronos Delay on make type BAR 0.1 Sec. - 10 Hrs. 240V AC; 24V AC/DC or 110V AC; 24V AC/DC or 12V DC	SBT00-00	1670
Delay on break type BCR 0.1 Sec. - 10 Hrs. 240V AC; 24V AC/DC or 110V AC; 24V AC/DC or 12V DC	SBT01-00	1820
Recycling type BDR 0.1 Sec. - 10 Hrs. 240V AC; 24V AC/DC or 110V AC; 24V AC/DC	SBT02-00	2350
Multifunction type BLR 0.1 Sec. - 10 Hrs. 240V AC; 24V AC/DC or 110V AC; 24V AC/DC	SBT03-00	1840
Star-Delta Timer Type DQR-0.2-20 Sec./1-100 Sec.; 415/240, 110V: AC	SDT00-0-	1685

- Voltage Code
- Timing Range for Star-Delta Timers & SAS Timer

Voltage Codes

Type	Voltage	Voltage Code
B	240V AC; 24 VAC/DC	1
	110 V AC; 24 VAC/DC	2
	12 V DC	5
D	240 V AC	1
	415 V/240 V AC	0
	110 V AC	2
SAS	240V AC	1
	110V AC	2
	48V AC/DC	3
	24V AC/DC	4

Timing Code

Type	Timing	Code
DQR (Star Delta Timer)	20 Sec.	0
	40 Sec.	1
	100 Sec.	2
SAS	1 Sec.	0
	10 Sec.	1
	100 Sec. 300 Sec.	2 3

Custom Built Products

- **MCC & PCC**
- **Crane Control Panels**
- **Punch Grid Resistors & Panels, NGR & DBR**
- **Special Purpose Starters**
- **Power Receptacles**
- **Auto Transformer Starters**

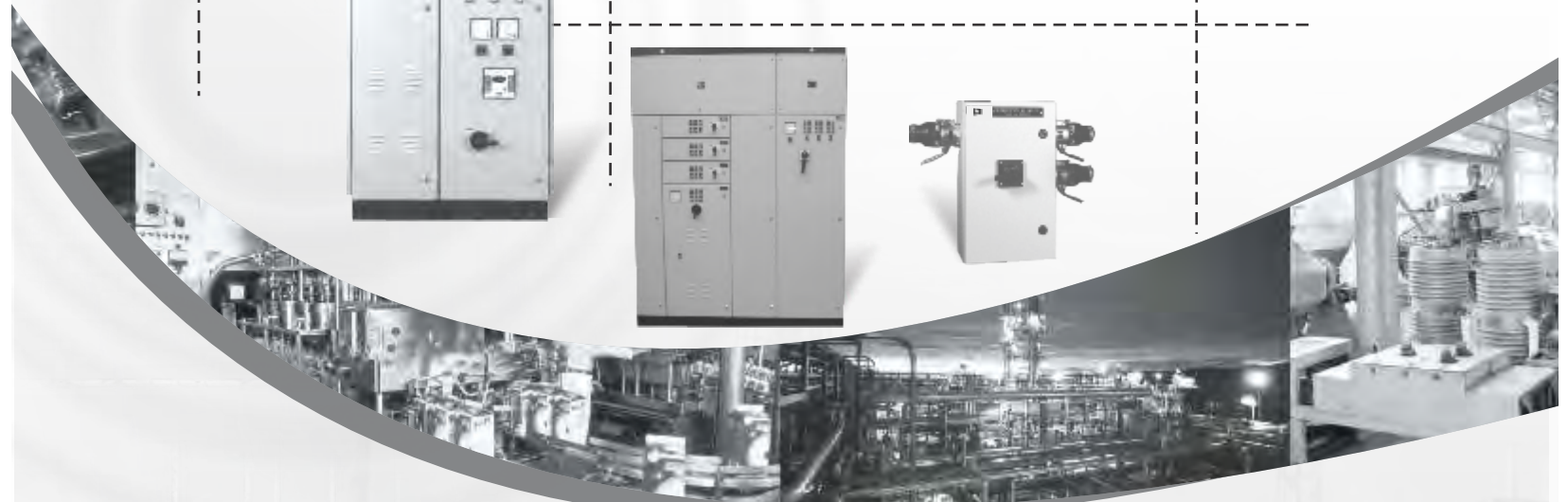

Motor Control Centres (MCC) & Power Control Centres (PCC)



BCH MCC & PCC

- Latest Design Concepts & Manufacturing Process.
- Robust Construction and Durable Finish for Rugged Application.
- Techno Modular Design with flexibility in construction / fully bolted with concealed hinges for all doors.
- Suitable for Indoor and Outdoor installations with IP-54 / 55 as per IEC 60529 : 2001
- Fixed & Withdrawable type in Single front & Double Front Execution upto Form-4B.
- Bus Bar Rating upto 6300A with E91E grade Aluminium / Electrolytic grade Copper Bus Bars.
- Type tested for Short Circuit 800A to 4000A for 50 KA rms / 1sec and 105KA peak fault withstand as per IS: 8623 and IEC: 61439.
- Type tested for Temperature Rise 800A to 4000A from CPRI Bhopal as per IS: 8623 and IEC: 61439.
- 10 Tank spray based tricationic phosphating treatment and electrostatic coating with epoxy based powder.
- Standard Paint Shades : RAL-7035, RAL-7032 and 631 as per IS:5 Structure Finish Powder Coating.
- All doors & covers are provided with PU Foam gasket to ensure the Ingress Protection.
- PU Foam gasket temperature withstand capacity -40 Deg C to + 100 Deg C.
- Panel height upto 2500mm (including 100mm High Plinth/Base).
- Panel Width 900mm Withdrawable execution & for Fixed Execution depends on application.
- 600mm for Single Front Withdrawable , 1200mm for Double Front Withdrawable & For Fixed Execution depends on application.

All tailor made solutions on request and based on specific enquiries. Contact nearest branch location for detailed proposal as per exact requirement.



AC Crane Control Bridge and Trolley Motion

This controller provides reversing and plugging operation of slip ring induction motors in heavy duty cranes on Trolley services. Upto 5 motor speeds are achieved in conjunction with a master controller.

Design Features

- Simplified reliable circuitary
- Inverse Time delay Magnetic Overload protection
- Time Limit acceleration
- Speed Control by series resistors
- No Volt protection
- Special Unique plugging circuit with a voltage relay
- CRCA Sheet steel construction of the panel.
- 7 Tank pretreated panels for extremely long life
- Panels for indoor and outdoor protection



AC Crane Control Hoisting Motion

- Plain rotor resistance
- AC Single phase dynamic braking
- Counter torque lowering
- Oprotor Control
- Creep Speed



DC Crane Control Hoisting Motion

This control is for use with series wound motors drive for crane hoists and is arranged for reversing and dynamic lowering service. control

Design Features

- Simplified reliable circuitary
- Inductive time limit acceleration on joisting & lowering
- Better speed control on light or heavy loads when hoisting or lowering
- CRCA Sheet steel construction of the panel.
- 7 Tank pretreated panels for extremely long life



DC Crane Control (Bridge and Trolley motion)

This controller provides reversing and plugging operation of series wound motors in heavy duty cranes on Trolley services. Upto 5 motor speeds are achieved in conjunction with a master controller.

Design Features

- Simplified, reliable circuitary
- Rectifier controlled plugging
- Instantaneous and Inverse time delay magnetic overload protection
- No volt protection
- Heavy duty DC Contactors equipped with magnetic blowouts
- CRCA Sheet steel construction of the panel.
- 7 Tank pretreated panels for extremely long life

Resistors & Starters..... BCH

GST to be charged extra on PGR Prices

**PGRs are 10 minutes rated.
Temp. rise : 375 deg over ambient**

Dimensions in mm (WxHxD) : 673x152x250 HSN Code - 8533

Punched Grid Resistors



Applications:

- Speed Control Resistors
- Starting Resistors for AC and DC Motors
- Dynamic Braking Resistors
- Neutral Grounding Resistors (upto 11KV)

Features

- Special Chromium Steel Alloy (AISI406) for :
 - a) Higher resistivity (approx 70% higher than others)
This results in overall light and compact unit
 - b) Low temperature coefficient (approx 72% lower than others)
This means negligible change in resistance values despite grid temperature variations (very important parameter in applications like crane controls)
 - c) Unbreakable and corrosion free Grids . Suitable for extreme vibration conditions
 - d) Drawout type of banks for ease of removal while replacements
 - e) Three rod construction for higher mechanical strength
 - f) Individual grids are T.I.G. welded for consistent current path
 - g) Unique design using staggered grid pattern ensuring maximum air circulation
 - h) Terminal designed for 2 types of conductors ensuring flexibility

We also manufacture NGRs & DBRs

Special Purpose Starters

- Direct ON Line Starters upto 500 HP
- Star Delta Starters upto 650 HP
- Closed Transition Star Delta Starters upto 650 HP
- Automatic Stator Rotor Starting Panels upto 1000 HP
- DC starter upto 600A

Type	Resistance Per Bank	Continuous Rating	LP
	Ohms	Amps	[₹]
WL10	0.1	225	14145
W12	0.125	200	12510
WL16	0.16	180	14450
WL20	0.2	150	14755
WL25	0.25	134	13025
WL32	0.32	118	11530
WL40	0.4	113	13340
WL50	0.5	100	11265
WL62	0.62	84	14545
WL80	0.8	75	13175
WL100	1	67	12255
WL125	1.25	64	13640
WL160	1.6	57	11770
WL200	2	54	13100
WL250	2.5	48	11565
WL320	3.2	43	10125
WL400	4	40	14110
WL500	5	35	10240
WL625	6.25	33	11695
WL800	8	29	10910
WL1200	12	21	11695
WL1600	16	19	11340

Dimensions in mm (WxHxD) : 800x152x250 HSN Code - 8533

Type	Resistance Per Bank	Continuous Rating	LP
	Ohms	Amps	[₹]
WLL20(M)-1	0.325	150	22945
WLL25(M)-1	0.54	134	21940
WLL32(M)-1	0.68	118	18605
WLL50(M)-1	0.864	100	15755



Power Receptacles..... BCH

Power Receptacles

Range

- Single / Multiple outlet boxes
- 16/32/63/125A rating
- With or without protection
- Option of back up protection with :
MCBs
SDFUs
MCCBs
- Modular and compact construction
- Loop in / Loop out facility
- Higher degree of Ingress Protection
- 7 Tank processed powder coated enclosure
- PU Gasketing for excellent sealing against dust and water



Plugs and Socket outlets with / without protection, mounted in CRCA enclosure of suitable size

Single Outlet	Incomer (1 No.)			Standard Version Cat reference	Loop in loop out version Cat reference
	Switch Type	MCCB Type	MCB		
1 No DS1A7A1 and 1 No. DS1B7A1	PSFS323ND000/ PSFS323ND00	-	-	PR16SDF-1	PR16SDF-1-LILO
1 No DS1A7A1 and 1 No. DS1B7A1	-	-	16A,TPN	PR16MCB-1	PR16MCB-1-LILO
1 No DS1A7A1 and 1 No. DS1B7A1	-	-	-	PR16WP-1	PR16WP-1-LILO
1 No DS3A7A1 and 1 No. DS3B7A1	PSFS323ND000/ PSFS323ND00	-	-	PR32SDF-1	PR32SDF-1-LILO
1 No DS3A7A1 and 1 No. DS3B7A1	-	-	32A,TPN	PR32MCB-1	PR32MCB-1-LILO
1 No DS3A7A1 and 1 No. DS3B7A1	-	-	-	PR32WP-1	PR32WP-1-LILO
1 No DS6A7A1 and 1 No. DS6B7A1	PSFS633ND000/ PSFS633ND00	-	-	PR63SDF-1	PR63SDF-1-LILO
1 No DS6A7A1 and 1 No. DS6B7A1	-	XFE063N+ separate Neutral Link + Rotary Handle	-	PR63MCCB-1	PR63MCCB-1-LILO
1 No DS6A7A1 and 1 No. DS6B7A1	-	-	63A,TPN	PR63MCB-1	PR63MCB-1-LILO
1 No DS6A7A1 and 1 No. DS6B7A1	-	-	-	PR63WP-1	PR63WP-1-LILO
1 No DS9A7A1 and 1 No. DS9B7A1	PSFS1253ND	-	-	PR125SDF-1	PR125SDF-1-LILO
1 No DS9A7A1 and 1 No. DS9B7A1	-	XF2H125NV+ separate Neutral Link + Rotary Handle	-	PR125MCCB-1	PR125MCCB-1-LILO
1 No DS9A7A1 and 1 No. DS9B7A1	-	-	-	PR125WP-1	PR125WP-1-LILO

Double Outlet

2 No DS6A7A1 and 2 No. DS6B7A1	-	XF2H125NV+ separate Neutral Link + Rotary Handle	-	PR63MCCB-2	PR63MCCB-2-LILO
2 No DS6A7A1 and 2 No. DS6B7A1	PSFS1253ND	-	-	PR63SDF-2	PR63SDF-2-LILO

* Prices : Available on request

Auto Transformer Starter Panels upto 800 HP

Advantages

- Good Starting Torque and current performance
- Possibility of adjusting starting parameters
- No break in supply to the motor during starting
- Best suited when maximum reduction of Inrush current is desired or motor requires longer acceleration time with Good starting torque

- Blowers
- Pumps
- Compressors
- Extruders
- Crushers

Range & Specifications

- Available upto 800HP
- Standard Tappings : 50% , 65% and 80%
- Air Cooled design
- 7 Tank pre treated bolted construction enclosure
- Superior gasket

Protections

- Short Circuit
- Overload and Single Phasing (Thru Overload relay)
- Under voltage
- Other protections available on request

Metering and indication

- Voltmeter with selector switch
- Ammeter with selector switch
- R, Y, B phase indication
- Motor ON, OFF and Trip indication



BCH advantage over conventional Oil Cooled design

CONVENTIONAL OIL COOLED	BCH AIR COOLED
AT is provided as a separate Unit	Panel Size is compact as AT is a part of the panel
Additional Wiring between AT and panel	Less wiring
Oil to be filled, which adds cost to the panel	No extra cost
Maintenance is costly as oil to be regularly monitored for its level , viscosity. When sludge is formed it needs to be replaced	Practically NO maintenance
Moisture in the oil can burn the Transformer so ATS cannot be installed in moisture prone areas	Suitable for all atmospheric conditions
Less initial cost but high running cost	Slightly high Initial cost but very less running cost

Auto Transformer BCH

HSN Code - 8537

BIL Auto Transformer Starter - STANDARD RATINGS	MODEL 1 - BASIC ATS : PU door-gasket Enclosure, 3nos. Power Contactor, Citation OLR, Start/Stop PB, Motor ON LED		MODEL 2 - PREMIUM Version : PU door- gasket Enclosure, MCCB Incomer, 3nos. Power Contactor, Citation OLR, Electronic SPP, Ammeter/voltmeter with selector switches, Start/Stop PB, Phase & Motor ON/Trip LEDs.	
HP	Cat. No.	MRP [₹]	Cat. No.	MRP [₹]
7.5	ATEA10/KOR	Contact Nearest Sales Office for Prices	ATPA10/KOR	Contact Nearest Sales Office for Prices
10	ATEA10		ATPA10	
15	ATEA15		ATPA15	
20	ATEA20		ATPA20	
25	ATEA25		ATPA25	
30	ATEA30		ATPA30	
35	ATEA40		ATPA40	
40	ATEA40		ATPA40	
50	ATEA50		ATPA50	
60	ATEA60		ATPA60	
75	ATEA75		ATPA75	
100	ATEA100		ATPA100	
125			ATPA125	
150			ATPA150	
175			ATPA175	
200			ATPA200	
225			ATPA225	
250			ATPA250	
300			ATPA300	
350			ATPA350	
400		ATPA400		



Price List

General Terms & Conditions

Prices are subject to change without any prior notice and will be applicable as prevailing at the time of dispatch.

- The prices are ex-works basis..
- The prices given in this list are effective as on date and are subject to change without notice.
- Maximum Retail Price (MRP) mentioned are inclusive of GST.
- The List Prices (LP) mentioned are exclusive of GST.
- The duties, taxes and other statutory levies are based on rates prevailing at the time of billing. Any subsequent revision of those rates having retrospective effective shall be to customer's account.
- In case where any GST exemption has been claimed, the purchaser is responsible for providing the necessary GST exemption form within the specified period, failing which the purchaser would be liable for the payment of full GST plus applicable interest and penalties
- All Prices are in Indian Rupees (₹).
- Alteration made after receipt of confirmation of order are subject to price & delivery revisions and any other expenses or levies
- The dispute, if any, will be resolved mutually by discussion. However, if no settlement is forthcoming then, the Courts at New Delhi shall only have territorial jurisdiction to hear and decide the dispute.

Warranty

All products, unless specifically mentioned otherwise, shall have warranty, against manufacturing defects for a period of 18* months from the date of invoicing & 24 months from date of manufacturing whichever is later subject to the provision of proper usage and does not cover defects arising out of fire, accident, inefficient maintenance, faulty operation and willful or accidental damage. The manufacturer shall not be liable for any consequential loss, injury or damages attributable to defect or failure of its products.

* Proof of purchase to be retained to avail warranty.

a strong commitment
to serve better
always ...



**Switchgear | Controlgear | Enclosures | Motor Starters & Submersible Pump Starters |
Brakes and Crane Controls | MCC | PCC | Customised Solutions | Automation |
Wires & Cables | Motors | Reactive Power Management**



**BCH
ELECTRIC
LIMITED**

Power Control Products

Starters & Submersible Pump Starters

Industrial Enclosures

Industrial Products

Wires & Cables

Motor Control Products

Customised Solution

Automation

a strong commitment to serve better always ...



BCH ELECTRIC LIMITED

Visit us at : www.bchindia.com

Corporate Office : 1105, New Delhi House, 27, Barakhamba Road, New Delhi-110 001 Tel. : 91-11- 43673100/23316029/3610/6539/ Fax : 91-11-23715247

CIN : U31103WB1965PLC026427, Customercare No. 1800-103-9262, E-mail : marketing@bchindia.com

Registered Office : Block 1E, 216, Acharya Jagadish Chandra Bose Road, Kolkata - 700 017

Works 1 : 20/4, Mathura Road, Faridabad-121 006 (Haryana) Tel. : 0129-4063000/4293000 Fax : 0129-2304016

Works 2 : 64-68, Sector-7, IIE, Pant Nagar, Rudrapur, Udham Singh Nagar - 263 153 (Uttarakhand) Tel. : 05944-250214/16 Fax : 05944-250215

Sales Offices :

Ahmedabad

103, Aaron,
Nr. SBI Laghuudyug branch,
Behind Sakar-1
Gandhinagar Railway station,
Ellis bridge, Ahmedabad - 380006
Tel. : 079-26589719
E-mail : ahmedabad@bchindia.com

Bangalore

2nd Floor, 130/5,
K.H. Road (Double road),
Bangalore - 560 027
Tel. : 080-22273478 / 22236759
E-mail : bangalore@bchindia.com

Bhubaneswar

Mallick Commercial
Complex Plot No.: A/69, unit - 3
Bhubaneswar - 751 001
Tel. : 0674-2380988
E-mail : bhubaneswar@bchindia.com

Chandigarh (Panchkula)

SCO -129, IInd Floor,
MDC, Sector-5 Panchkula,
Haryana-134 109
Tel. : 0172-5078957 / 5049905
E-mail : chandigarh@bchindia.com

Chennai

Flat No. 3A, 3rd Floor,
Sree Apartments,
No.508, TTK Road,
Alwarpet, Chennai 600 018
Tel. : 044-24337046, 24337047
E-mail : chennai@bchindia.com

Coimbatore

87, Dr. Nanjappa Road,
Coimbatore - 641 018
Tel. : 0422-2305311 / 2302599
E-mail : coimbatore@bchindia.com

Dehradun

8, Co-operative Industrial Estate,
Patel Nagar, Dehradun-248001
E-mail : dehradun@bchindia.com

Faridabad

20/4, Mathura Road,
Faridabad - 121 006 (Haryana)
Telfax. : 0129-4293009
E-mail : faridabad@bchindia.com

Hyderabad

1-8-303/48/13/102, Arya One,
2nd Floor, P. G. Road,
Secunderabad - 500 003
Tel. : 040-66206263/27890306
Fax : 040-66207273
E-mail : hyderabad@bchindia.com

Indore

330-331, Indraprastha Tower,
3rd Floor, 6, M.G. Road,
Indore - 452 001
Tel. : 0731-2510011 / 2510012
E-mail : indore@bchindia.com

Jaipur

25, Hathroi, Gopalbari,
Jaipur - 302 001
Tel. : 0141-2363521
E-mail : jaipur@bchindia.com

Jamshedpur

3rd Floor, Aastha Trade Centre,
'Q' Road, Bistupur,
Jamshedpur - 831 001
Tel. : 0657-2321097/2321481
E-mail : jamshedpur@bchindia.com

Kolkata

Block 1E, 216,
Acharya Jagadish Chandra Bose Road,
Kolkata - 700 017
Tel. : 033-22871728 / 46021884
E-mail : kolkata@bchindia.com

Lucknow

Madan Plaza, 3rd Floor,
14, Station Road,
Lucknow - 226 001
Tel. : 0522-4025597/4025997
Fax : 0522-4025697
E-mail : lucknow@bchindia.com

Ludhiana

S.C.O. - 18, 2nd Floor,
Feroze Gandhi Market,
Ludhiana - 140 001
Tel. : 0161-5021807/5022808
E-mail : ludhiana@bchindia.com

Mumbai

A-151, Mittal Tower,
Nariman Point,
Mumbai - 400 021
Tel. : 022-22822947/22850162
Fax : 022-22822858
E-mail : mumbai@bchindia.com

New Delhi

801, Akash Deep Building,
26A, Barakhamba Road,
New Delhi - 110 001
Tel. : 011-23313878/23739230
E-mail : delhi@bchindia.com

Pune

8, Sarosh Bhavan,
16-B/1, Dr. Ambedkar Road,
Pune - 411 001
Tel. : 020-26052590 / 26135224
E-mail : pune@bchindia.com

Raipur

2nd Floor, Building No. B-234,
Indira Gandhi Vyavasayik Parisar,
Pandri, Raipur - 492 004
Tel. : 0771-4020213 / 4045053
E-mail : raipur@bchindia.com

Trichy

2B, Kannagi Street,
Ayyappa Nagar, K.K.Nagar
Trichy - 620 021, Tamilnadu
Tel. : 0431-4040497
E-mail : trichy@bchindia.com

Vadodara

301, Third Floor, "Florence Classic",
10, Ashapuri Co-Op. Hsg. Soc. Ltd., Opp. VUDA Housing,
Near Cow Circle, Akota, Vadodara - 390 020
Tel. : 0265-2345068/2345069
Telefax : 0265-2345068,
E-mail : vadodara@bchindia.com

Other Branch Locations

Bhubaneswar : bhubaneswar@bchindia.com, **Cochin :** cochin@bchindia.com, **Gurgaon :** gurgaon@bchindia.com, **Guwahati :** guwahati@bchindia.com, **Hospet :** hospet@bchindia.com,
Hubli : hubli@bchindia.com, **Madurai :** madurai@bchindia.com, **Nagpur :** nagpur@bchindia.com, **Vishakapatnam :** vizag@bchindia.com, **Surat :** surat@bchindia.com

Resident Engineer Locations

Baddi	Gurgaon	Madurai	Rajahmundry
Bardhaman	Haridwar	Muzaffarnagar	Salem
Bhilai	Hubli	Nagpur	Surat
Bhubaneswar	Hospet	Nashik	Udaipur
Cochin	Jodhpur	Patna	Vapi
Dehradun	Kakinada	Puducherry	Vishakhapatnam
Durgapur	Kota	Rajkot	Warangal

Since product improvement is a continuous process, the data furnished in this brochure may undergo revision without prior notice.